

G77x Intermittent Pilot Ignition Controls



Figure 1: G77x Intermittent Pilot Ignition Controls

Description

The G77x family of controls is designed for indirect ignition of natural gas, Liquefied Petroleum (LP) gas, manufactured gas, mixed gas, or LP gas-air mixtures.

Application Requirements

Following are the application requirements of the G77x control.

- The G77x can be used on gas-fired equipment with a maximum firing rate of 117 kW (400,000 Btu/hr). Any application over 117 kW (400,000 Btu/hr) must have written approval in advance from the Johnson Controls Heating Products Engineering Department.
- All G77x applications must use a redundant gas valve system where the pilot and main valve seats are in series and opened in sequence for intermittent pilot ignition.

Table 1: Specifications

Ignition Type	Indirect
Ignition Source	High voltage spark, capacitive discharge
High Voltage Cable Maximum Length	1,220 mm (48 in.)
Flame Sense Cable Maximum Length	1,220 mm (48 in.)
Flame Detection Means	Flame rectification
Flame Detection Types	Integral and remote
Minimum Flame Current	0.15 microampere
Flame Failure Response Time	0.8 second maximum 1.5 seconds maximum (G776_G models only)
Spark Gap	2.5 mm (0.1 in.) nominal
Ignition Trials	1 or 3
Ignition Trial Times	8, 25, 50, 85, or 120 seconds*
Prepurge Times	0, 4, 15, or 30 seconds*
Interpurge	0, 15, or 30 seconds*
Automatic Recycle Delay Period	No recycle (G770, G777) 5 minutes* (G775, G779) 60 minutes* (G776, G778)
Power Requirements	Control: 24 VAC, 60 Hz, nominal Operation Current: 0.2A nominal + valves
Contact Rating	Main Valve: 2A continuous, 5A inrush Pilot Valve: 2A continuous, 5A inrush
Ambient Operating and Storage Temperature	-40 to 70°C (-40 to 160°F) standard models -40 to 80°C (-40 to 175°F) high temperature models
Humidity	95% RH non-condensing
Wiring Connections	Spark: Spike, Rajah, or 6.35 mm (1/4 in.) male spade Control: 6.35 mm (1/4 in.) male spade 4.76 mm (3/16 in.) male spade optional
Types of Gas	Natural, Liquefied Petroleum (LP), manufactured, mixed, or LP gas-air mixture
Packaging	Bulk pack supplied to original equipment manufacturer (individual pack optional).
Bulk Pack Quantity	50
Bulk Pack Weight	15 kg (33 lb)
Agency Listing	CSA (AGA/CGA) Certificate Number 164933-1073441 Australian Gas Certificate Number 4524 (G770 models only)
Specification Standards	ANSI Standard Z21.20, Z21.20a, Z21.20b CAN/CSA-C22.2 No.199

*Timings listed are for 60 Hz operation. Timings increase 20% for 50 Hz operation.

The performance specifications are nominal and conform to acceptable industry standards. For application at conditions beyond these specifications, consult the local Johnson Controls office. Johnson Controls, Inc. shall not be liable for damages resulting from misapplication or misuse of its products.

Refer to the G77x Series Product Bulletin (LIT-4350430) for necessary information on operating and performance specifications of this product.

**Operating
Mode
Definitions**

The following definitions describe operating conditions:

- *Prepurge*--Initial time delay between thermostat contact closure and trial for ignition.
- *Trial for Ignition*--Period during which the pilot valve and spark are activated, attempting to ignite gas at the pilot burner. The control attempts to prove flame at the pilot burner within the trial-for-ignition time.
- *Run*--Pilot and main gas valves remain energized and spark is turned off after successful ignition.
- *Shutoff*--Pilot gas did not ignite within the trial-for-ignition time. The control de-energizes the spark circuit and pilot valve, and enters automatic recycle period.
- *Automatic Recycle*--If shutoff occurs, the control delays for a specific recycle delay period before beginning another trial for ignition (models with recycle only).
- *Interpurge*--Period between trials for ignition when both the gas valve and spark are deactivated to allow unburned gas to escape before the next trial. Interpurge occurs between unsuccessful trials on a multi-trial control or after a flameout (if the control has an interpurge).
- *Ignition Lockout*--Pilot gas did not ignite within the final trial-for-ignition time. Open thermostat contacts for 30 seconds, then close, to restart the sequence of operation. (Models with an optional Light-Emitting Diode (LED) will flash the LED to indicate ignition lockout.)
- *Flameout*--Loss of proven flame.
- *Hard Lockout*--The control detected a fault. Open thermostat contacts for 30 seconds, then close to restart the sequence of operation. (Models with an optional LED will turn off the LED to indicate a hard lockout.)

Sequence of Operation

Figure 2 illustrates the sequence of operation of the G77x control.

The control is energized on a call for heat from the system thermostat. (Models with an optional LED will turn on the LED [steady on] until the call for heat is satisfied.) The vent damper, if used, is energized and when fully opened, also energizes the ignition control. If the control is equipped with the optional prepurge, the appliance prepurge fan or relay is also energized through the thermostat contacts. In the prepurge mode, the control will delay for the time selected (e.g., 15 seconds) before simultaneously opening the pilot valve and supplying a continual spark at the pilot burner. If prepurge is not selected, the pilot valve is opened and spark initiated within one second after the call for heat.

Under normal conditions, the pilot burner gas ignites within the trial-for-ignition time (e.g., 8 seconds), the pilot flame sensor detects pilot flame, and signals the control to energize the main valve. The main gas valve will not be energized until the flame sensor detects the presence of pilot flame. The spark will continue until flame is sensed at the pilot burner or the trial-for-ignition period has elapsed, whichever occurs first. If the pilot flame is not sensed before the end of the trial-for-ignition period, the control may:

- proceed to interpurge, followed by another trial (three trial models whose first two trials produced no flame)
- proceed to a lockout (no automatic recycle models whose final trial produced no flame)
- proceed to a recycle delay period followed by another trial (automatic recycle models whose final trial produced no flame)

If the pilot burner flame extinguishes during the run state (flameout), the control de-energizes the pilot and main gas valve for the interpurge period. After this period, another trial for ignition is initiated. If the flameout cycle repeats for a total of 16 times (pilot burner flame established then lost), the control will:

- Enter the lockout mode if the control is a G770/G777. The thermostat contacts must be opened for 30 seconds and then closed to escape the lockout condition.
- Enter the shutoff mode and recycle period (5 minute recycle for the G775/G779 and 60 minute recycle for the G776/G778) before beginning another trial for ignition, starting with prepurge.

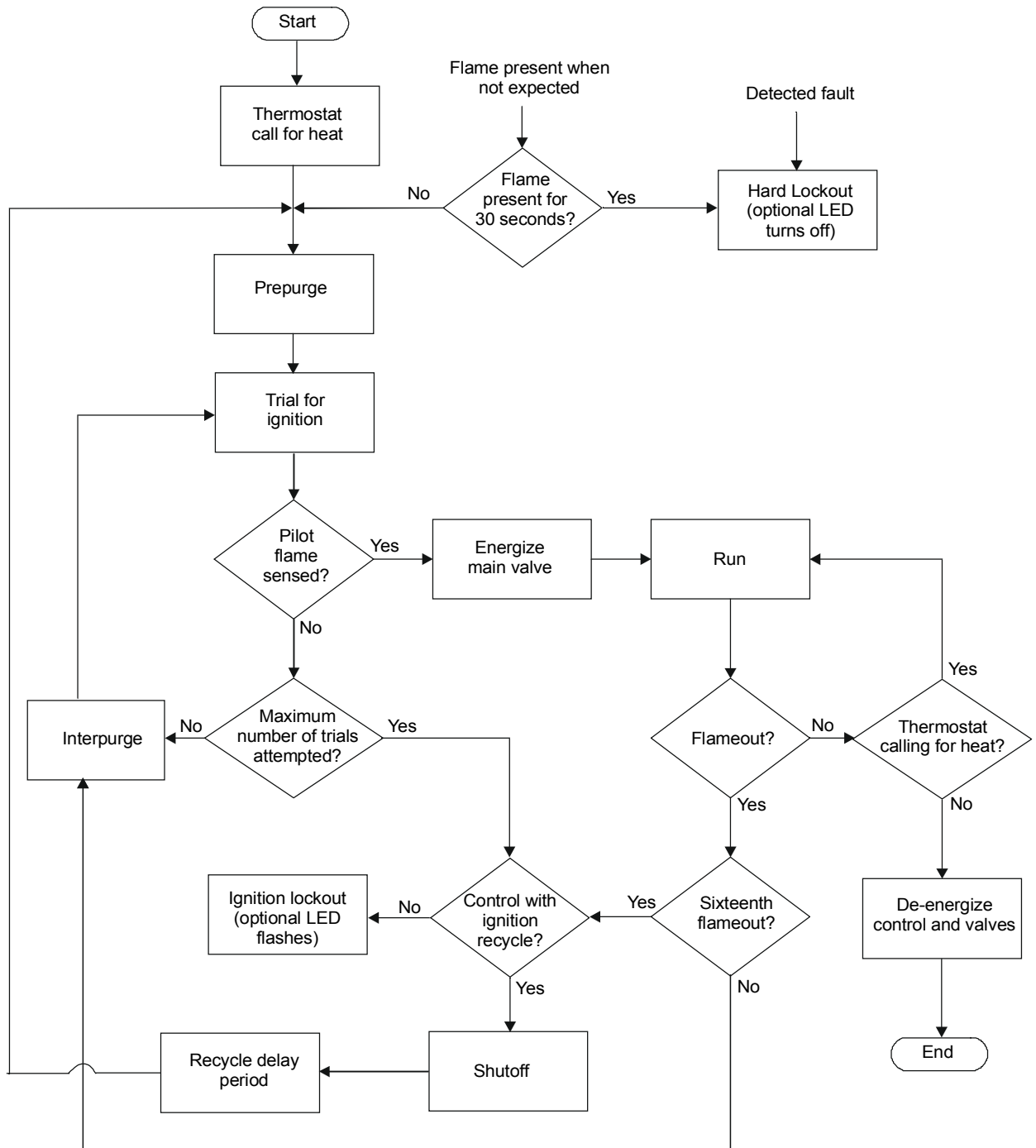



Figure 2: G77x Sequence of Operation

Installation and Wiring

IMPORTANT: These instructions are intended as a guide for qualified personnel installing or servicing Johnson Controls ignition controls. Carefully follow all instructions in this bulletin and all instructions on the appliance. Limit repairs, adjustments, and servicing to the operations listed in this bulletin or on the appliance.

 **WARNING: Fire or Explosion Hazard.** Avoid serious injury by carefully following precautions in this bulletin and all instructions on the appliance. Limit repairs, adjustments, and servicing to the operations listed in this bulletin or on the appliance.

 **WARNING: Fire or Explosion Hazard.** If the control is installed in an area that is exposed to water (dripping, spraying, rain, etc.), it must be protected. If the control has been exposed to water in any way, do not use it.

Location and Mounting

 **WARNING: Shock Hazard.** Avoid electrical shock and equipment damage. Disconnect electrical power and turn off gas before wiring control into circuit.

 **CAUTION: Equipment Damage Hazard.** Do not mount the control where it will be exposed to direct infrared radiation from the main burner or to temperatures in excess of the maximum product temperature rating.

Choose a location that provides the shortest, direct cable route to the spark electrode, pilot burner/igniter-sensor assembly. Easy access to the terminals is desired for wiring and servicing. The control may be mounted in any position. Mount the control on a grounded metal surface with metal screws or bolts through the mounting holes provided in the enclosure.

Electrical Connections



CAUTION: Equipment Damage Hazard. Connect the high voltage cable to the spark transformer terminal and spark electrode (pilot burner assembly) before applying power to the control. Be certain the ground wire is attached to the pilot burner and control ground terminal strip.



CAUTION: Equipment Damage Hazard. Locate all limit and operating controls in series with the thermostat terminal (THS 2) on the ignition control.

Check the voltage rating marked on the control and make sure it is suited to the application. Use a National Electrical Code (NEC) Class 2 transformer to provide 24 VAC under maximum load, including valves. A transformer having excessive primary impedance due to poor coupling will affect the ignition potential.

Refer to Figures 3 through 7 for wiring diagrams. All wiring should be in accordance with the NEC and all other local codes and regulations. The high voltage spark transformer cable must not be in continuous contact with a metal surface. Use standoff insulators. Ensure that the flame sensor wire and the high voltage spark transformer cable are separated from one another a minimum of 6.35 mm (1/4 in.) and not wrapped around any pipe, other wiring, or accessories.

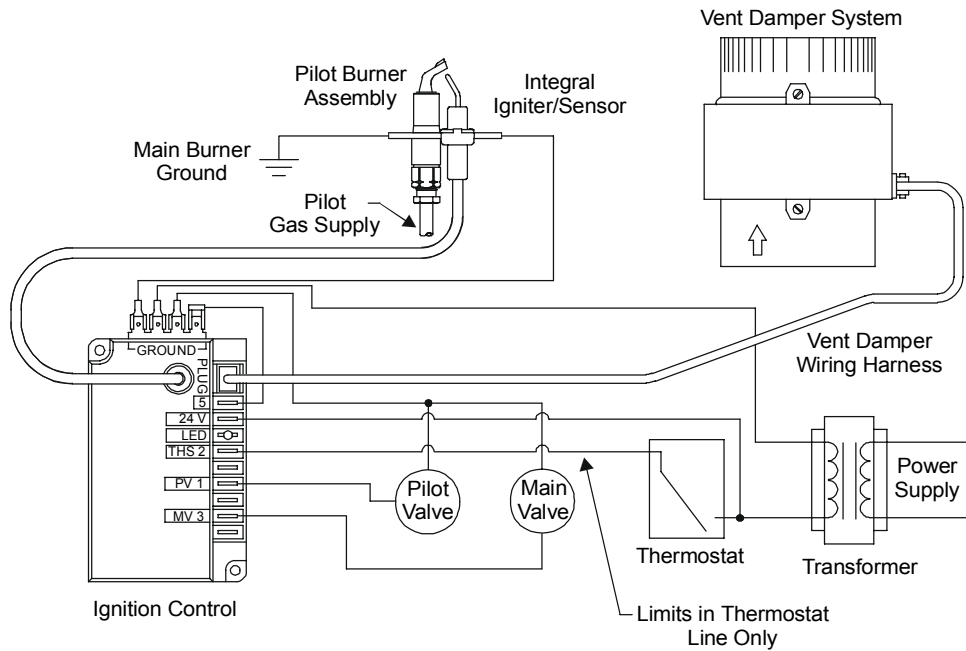

Figure 3: Wiring Diagram for Integral Spark/Sense with Vent Damper

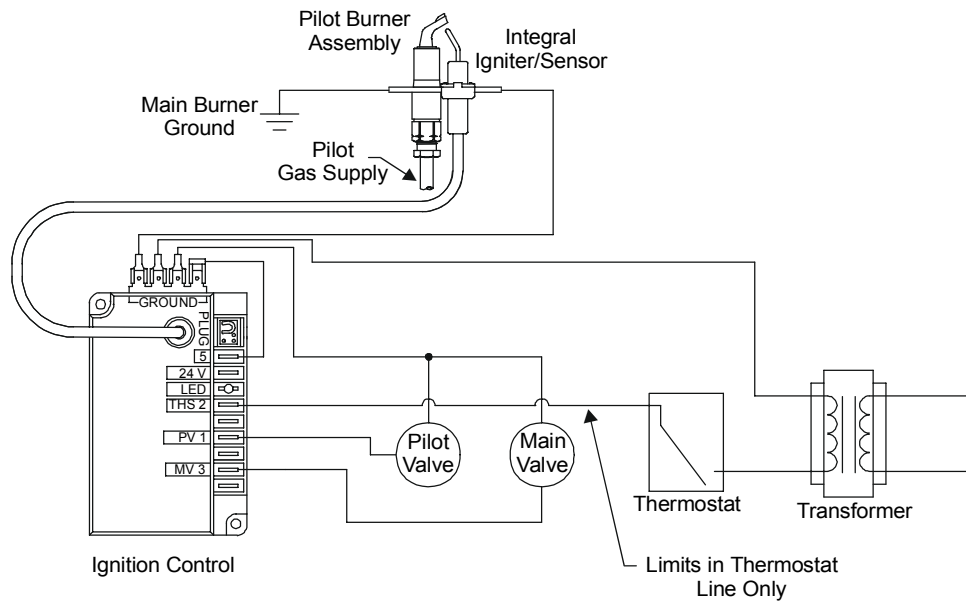

Figure 4: Wiring Diagram for Integral Spark/Sense without Vent Damper

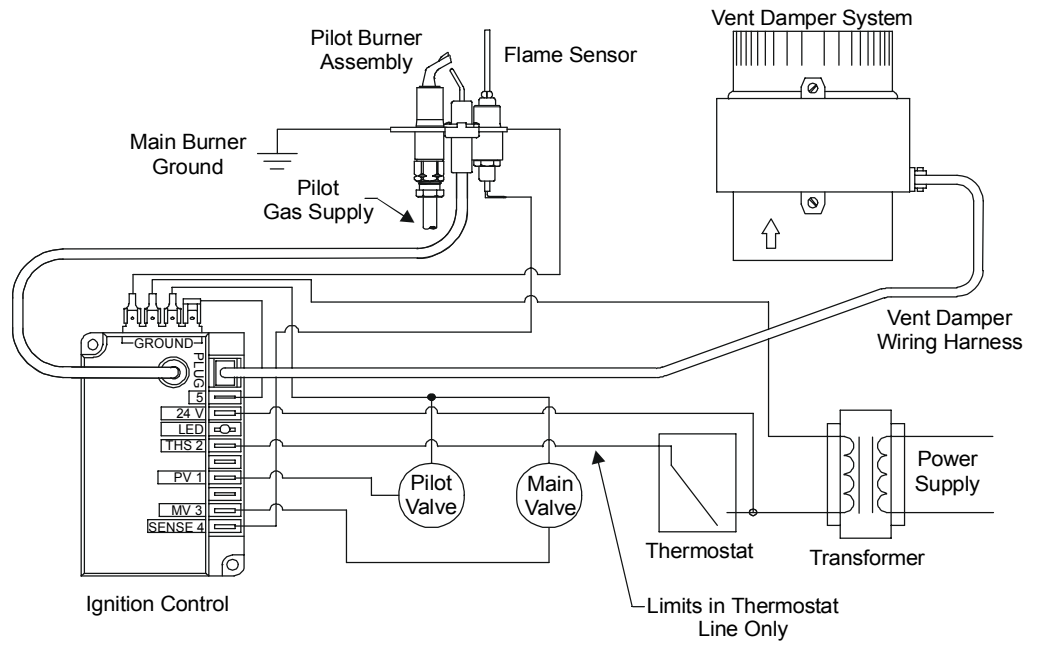

Figure 5: Wiring Diagram for Separate Spark/Sense with Vent Damper

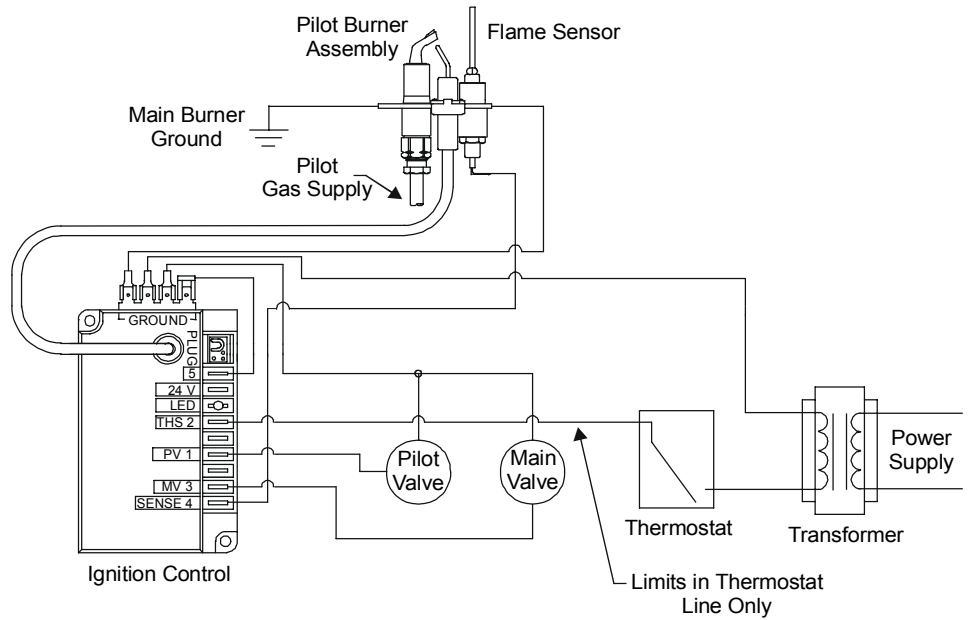

Figure 6: Wiring Diagram for Separate Spark/Sense without Vent Damper

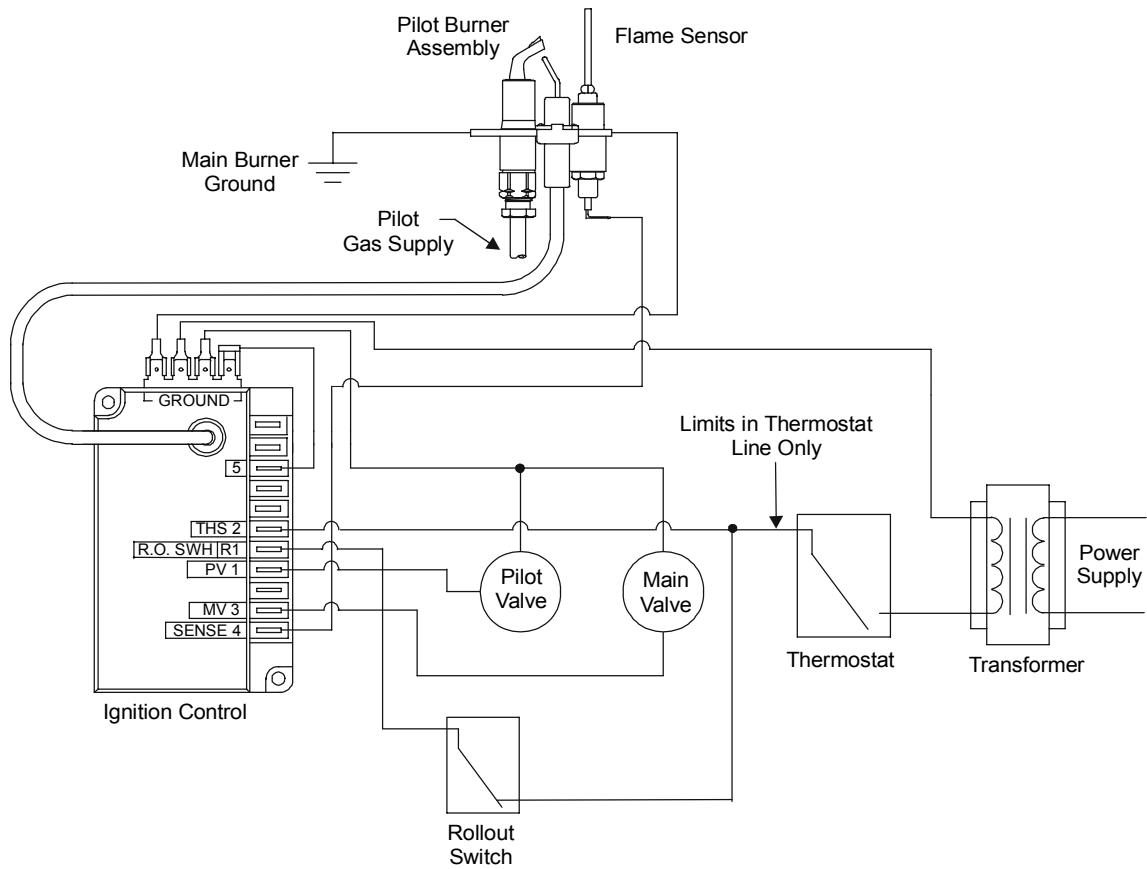

Figure 7: Wiring Diagram for G77x with Rollout Switch Terminal

Rollout Switch Function

The rollout switch is wired into the G77x ignition control at terminal R1 (see Figure 7). The rollout switch (a normally closed set of contacts) is positioned to detect flames rolling out of the combustion chamber. If rollout occurs, the switch contacts open and the G77x immediately goes into a lockout condition, closing the main and pilot valves so that the system is not allowed to function.

The thermostat contacts must be opened for 30 seconds, then closed to escape the lockout condition. When the rollout switch contacts have returned to the closed position, the G77x will start its operating sequence when the thermostat contacts close.

**Pilot
Burner/Igniter-
Sensor**

Instructions for installing the spark electrode and sensor assembly are typically provided by the appliance manufacturer. It is important to follow those instructions. If such information is not included, use the following basic instructions.

Location/Mounting

The pilot burner/igniter-sensor must be positioned for easy access and securely mounted to the main burner to ensure that the pilot burner flame remains properly positioned with respect to the main burner flame. The pilot burner must be located such that the flame receives an ample supply of air free from the products of combustion. The flame must not be exposed to draft conditions, the full force of main burner ignition, or falling scale, which could otherwise impede ignition of main burner flame.

The pilot burner/igniter-sensor should be securely mounted to the main burner with metal screws at a distance approximately 9.52 mm (3/8 in.) above and 6.35 mm (1/4 in.) away from center of the nearest main burner port. Ensure that the main burner flames do not impinge on any part of the pilot burner.

Make sure that the flame sensor wire and the high voltage spark transformer cable are separated from one another by a minimum distance of 6.35 mm (1/4 in.) and not wrapped around any pipe, other wiring, or devices.

**Checkout and
Startup
Procedure**

 **WARNING: Fire or Explosion Hazard.** Avoid personal injury or property damage by making sure the control functions properly and there are no gas leaks. Follow this checkout and startup procedure before leaving the installation.

 **WARNING: Fire or Explosion Hazard.** Do not attempt to check out this system by manually lighting the pilot. This could energize the main valve.

Make sure all components function properly by performing the following shutoff test.

1. With the gas and thermostat off, turn on power to the appliance.
2. Turn the thermostat to the highest setting and verify that the control goes through the operating sequence to a shutoff condition.
Note: The burner will not light because the gas is off.
3. Turn off the thermostat.
4. Turn on the gas and purge gas lines of all air.
5. Check for gas leaks on all pipe joints upstream of the gas valve with a soap solution.
6. Turn the thermostat to the highest setting and verify successful ignition and a normal run condition for at least three minutes. If the appliance fails to run, see the *Service Checkout Procedures* section.
7. Check for gas leaks on all pipe joints downstream of the gas valve with a soap solution.
8. Turn the thermostat down for at least 30 seconds, and then back up again. Verify successful ignition at least three times.
9. Return the thermostat to a normal temperature setting before leaving the installation.

**Thermostat
Heat
Anticipator
Settings**

The anticipator setting is normally equal to the ignition system current draw, plus that of the pilot and main valve.

Due to variations in appliance wiring and valves, it is advisable to measure the actual current draw of the heating system at the thermostat location. Measuring this current can be accomplished by opening the thermostat contacts (lowering the setpoint) and installing an AC ammeter across the terminals, or by using a clamp-on ammeter with a 10-turn multiplier attached to the terminals. See Figure 8.

IMPORTANT: Measuring the current with an ammeter will energize the system. Wait until the appliance is in the run condition before taking a current draw measurement.

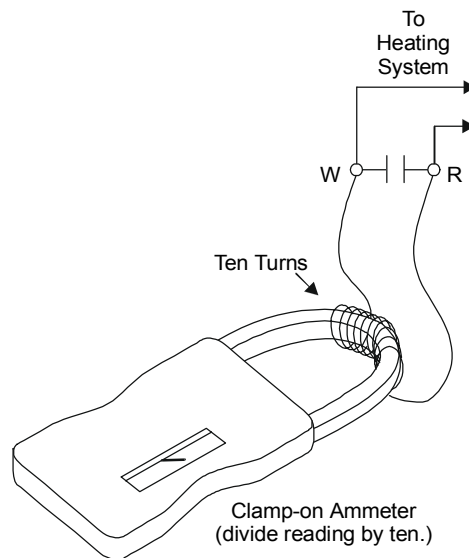
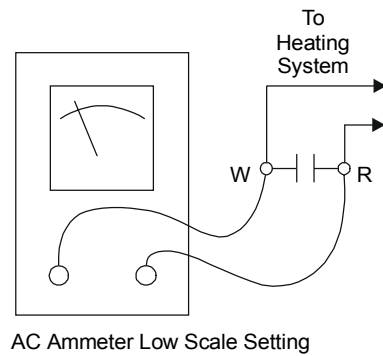



Figure 8: Measuring the Thermostat Current

Replacement Procedure

 **WARNING:** **Shock Hazard.** Avoid electrical shock and equipment damage. Disconnect electrical power and turn off the gas before wiring the control into the circuit.

 **CAUTION:** **Equipment Damage Hazard.** Label all wires prior to disconnection when servicing controls. Wiring errors can cause improper and dangerous operation. Verify proper operation after servicing.

Perform the following procedure to replace the existing intermittent pilot ignition control.

1. Shut off power to the appliance.
2. Turn off the gas at the manual shutoff valve adjacent to the appliance.
3. Label each wire with the correct terminal designation prior to disconnection.
4. Disconnect the power supply (transformer) and the thermostat lead wire at the ignition control.
5. Disconnect the sensing probe lead from Terminal 4 on the ignition control (separate spark/sense models only).
6. Disconnect the high voltage cable from the spark transformer.
7. Disconnect the Pilot Valve 1 and Main Valve 3 leads from the ignition control.
8. Disconnect any wires connected to the ground terminals.
9. Remove the screws holding the ignition control assembly in place.
10. Remove the ignition control and discard.
11. Using the same holes as the old ignition, mount the new control with metal screws or bolts through the mounting holes in the enclosure.
12. Refer to the *Installation and Wiring* section for electrical connections and wiring information. The replacement G77x control has a Spike transformer connection. Refer to the *Modifying Existing Ignition Cable* section for connection to a Spike transformer.
13. Perform the *Checkout and Startup Procedure* before leaving the installation.

Modifying Existing Ignition Cable

All spark ignition controls have a spark transformer connected to a high voltage cable. There are three types of connections for the high voltage cable: Spike, Rajah, and 6.35 mm (1/4 in.) male spade (see Figure 9). The replacement G77x has a Spike transformer. When replacing a control that has a Rajah or male spade connection, the crimp-on connector must be cut off and connected as follows.

1. Slide the rubber boot up the cable.
2. Cut the lead just above the connector (see Figure 10). Make a straight cut perpendicular to the cable.
3. Center the exposed wire on the end of the lead over the spike in the spark transformer and push the wire lead down firmly over the spike (see Figure 11).
4. Ensure the lead is inserted all the way into the spark transformer. Slide the boot back down the cable and over the spark transformer.



Figure 9: High Voltage Cable Connectors

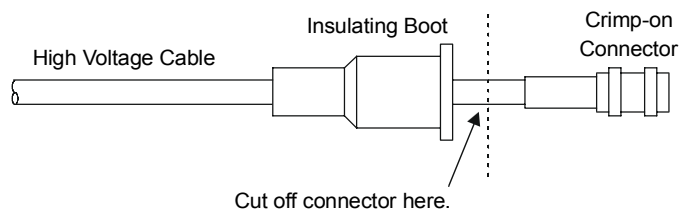

Figure 10: High Voltage Cable with Crimp-On Connector

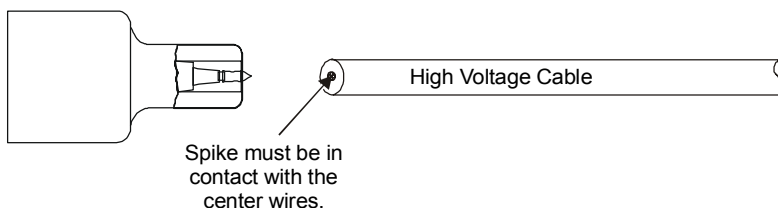

Figure 11: Spark Transformer Connection

**Service
Checkout
Procedures**



WARNING: Fire or Explosion Hazard. Do not attempt servicing or troubleshooting when the LED is flashing (recycle mode or ignition lockout). The control automatically energizes the system and could cause personal injury or property damage.

If the system does not function properly, determine the cause using the procedures in this section.

**Preliminary
Checks**

Before proceeding with troubleshooting the system, check the following:

- Are all mechanical and electrical connections tight?
- Is the system wired correctly?
- Is gas inlet pressure per manufacturer's specifications?
- Is the system powered?
- Is the thermostat calling for heat?
- Is the optional LED flashing? If so, the control is in recycle mode or it has entered an ignition lockout.
- Is the optional LED off? If so, the control is not receiving power, or it has detected a fault. Faults are:
 - flame present for more than 30 seconds at call for heat
 - a defective control

**Failure
Conditions and
Corrective
Action**

There are three potential system failure conditions:

- No spark present, and system does not work.
- Spark is present, but pilot does not light.
- Pilot lights, but main burner does not come on.

Determine the failure condition, then use the respective flowchart on the following pages to troubleshoot the system. Perform the procedures in the *Checkout and Startup Procedure* section after any servicing.

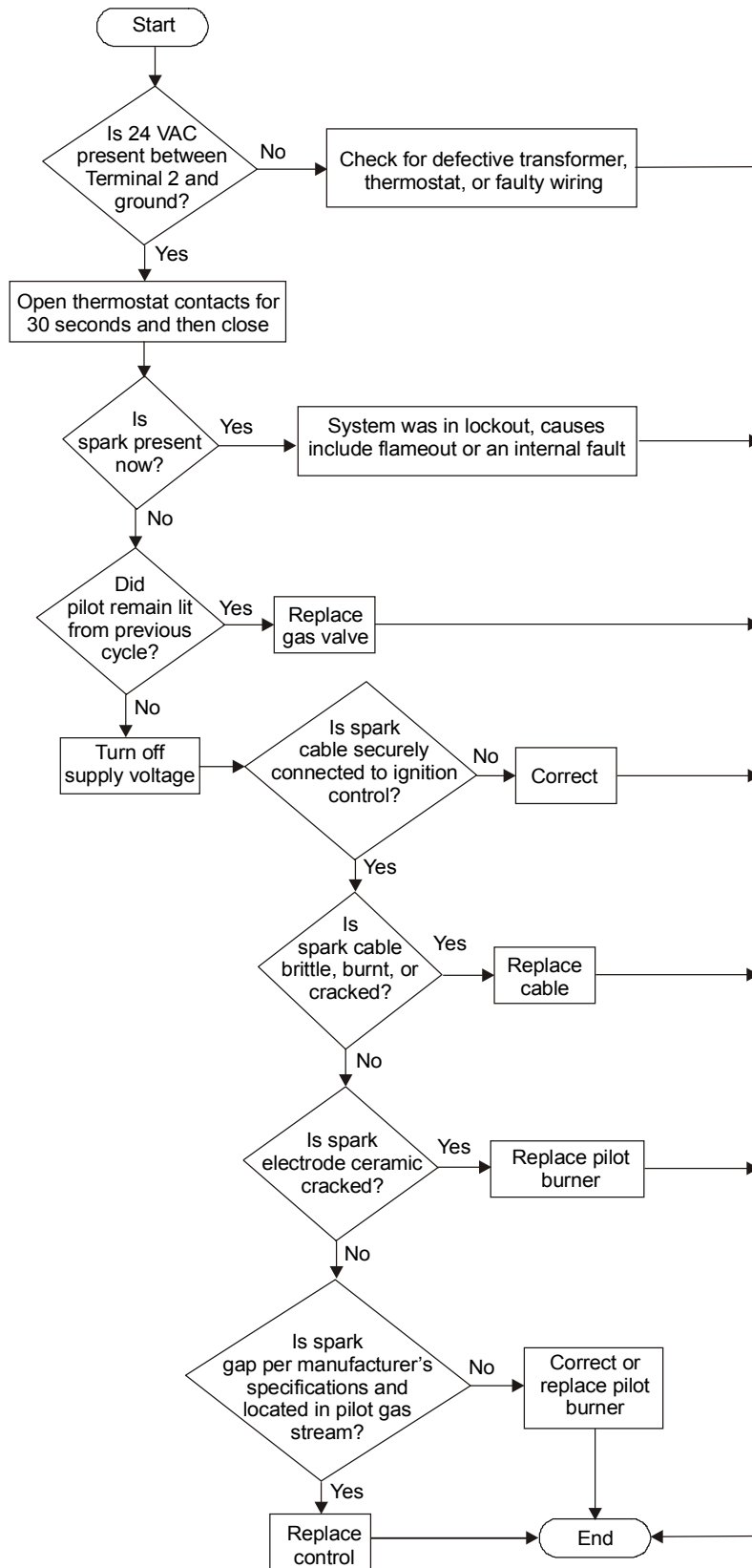

Figure 12: No Spark, and System Does Not Work

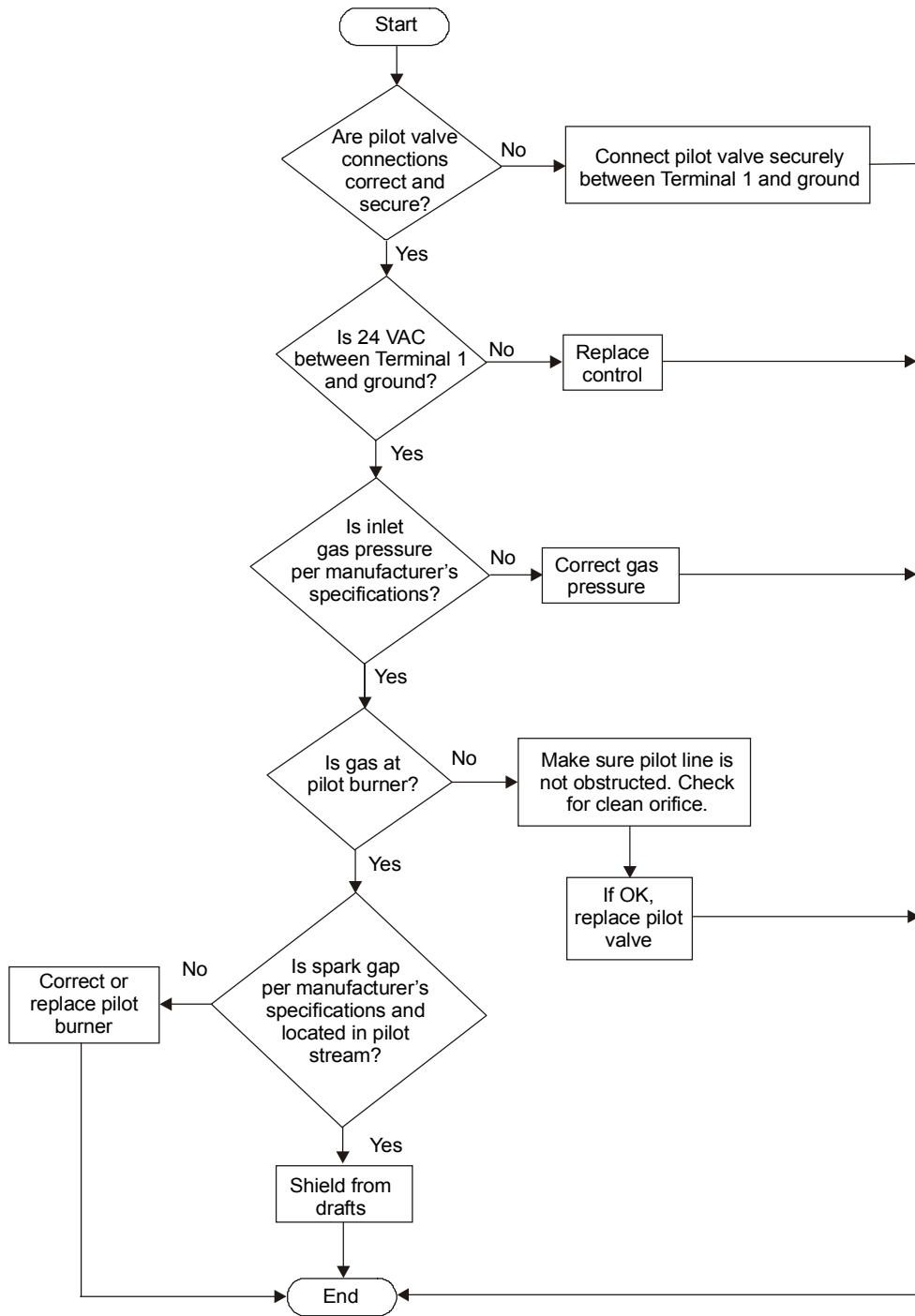

Figure 13: Spark Present, but Pilot Does Not Light

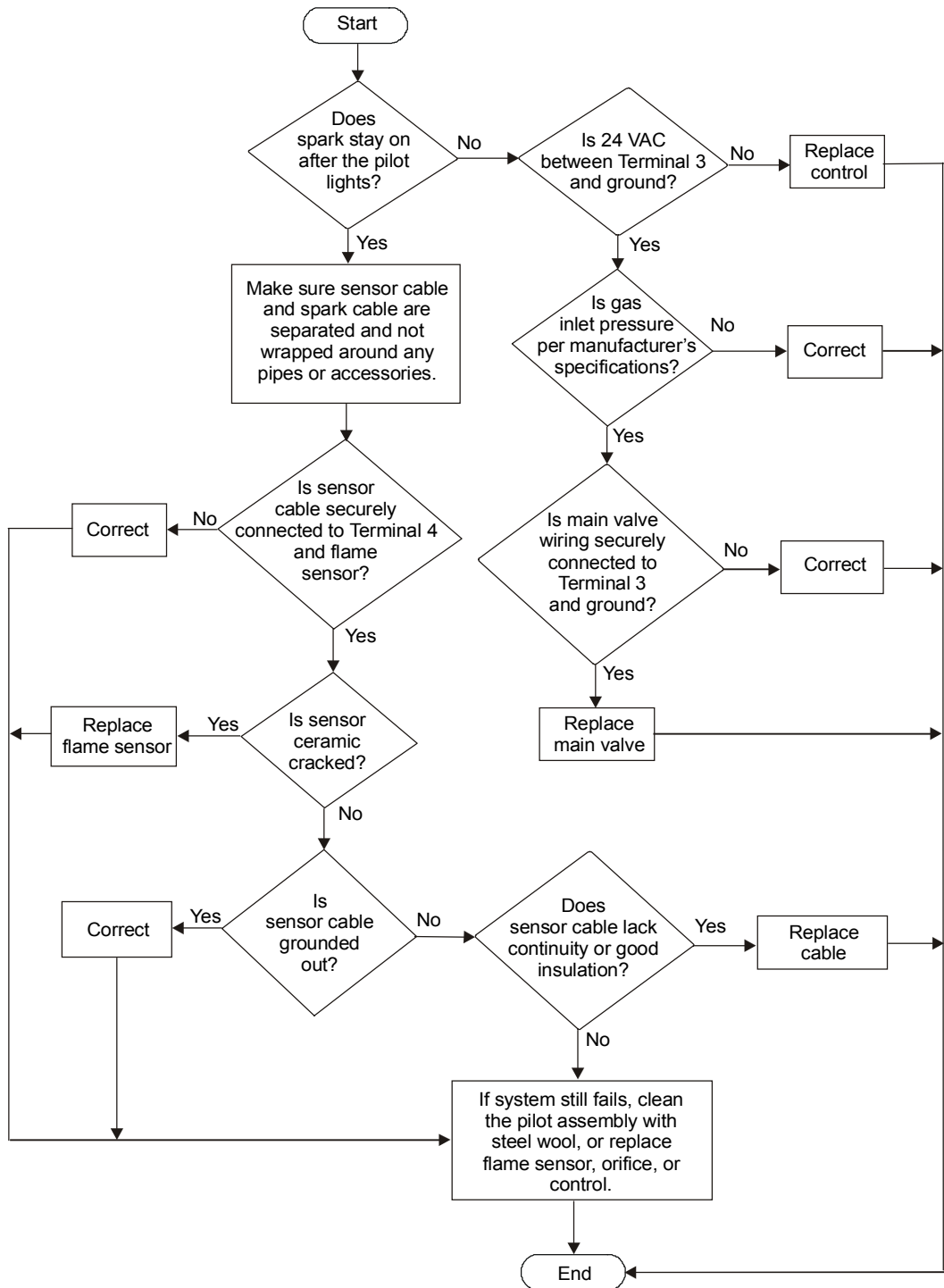

Figure 14: Pilot Lights, but Main Burner Does Not Come On

Repairs and Replacement



CAUTION: Label all wires prior to disconnection when servicing controls. Wiring errors can cause improper and dangerous operation. Verify proper operation after servicing.

The G77x controls are not field repairable. **Do not** attempt field repairs. Use only an exact or factory recommended replacement control.

All other accessories, such as flame sensors, electrode assemblies, pilot assemblies, and leads can be obtained through the original equipment manufacturer or a Johnson Controls distributor.



Controls Group
507 E. Michigan Street
P.O. Box 423
Milwaukee, WI 53201

www.johnsoncontrols.com
FAN 121
Installation Sheets Manual
Printed in U.S.A.