

Replacement Parts

Applies to: Model F and Model FE
Fan-Type, Gas-fired
Unit Heaters and
Model B and Model BE
Blower-Type, Gas-fired
Unit Heaters

IMPORTANT

1. Always include complete heater model and serial number so that any specification change can be considered for parts shipment. It can save time and expense.
2. Specifications are subject to change without notice.
3. We reserve the right to substitute functional replacements
4. Order by Part Number. Do not order by Option Number.

**Model F, Fan-Type,
Gravity Vent**



**Model B, Blower-Type,
Gravity Vent**



***Model FE, Fan-Type,
Power Vent**



***Model BE, Blower-
Type, Power Vent**





*Models FE and BE are no longer manufactured.

Index

A	Hinge Pin Assy 16	Relay 4, 6, 14, 15
Air Shutter 12	I	Replacement Parts Tag 2
B	Ignition Controllers 5	Restrictor 8
Belt 10, 11	Ignition Conversion Kits 5	S
Belt Guard 19	K	Sail Switch 15
Blocked Vent Switch 4	Key 8	Sensing Tube 14
Blower 8	L	Serial Number 3
Blower Components 8	Latch Fastener 16	Starter 9
Blower/Filter Cabinet 19	Limit Control 4	Starters 10
Blower Guard 19	Vertical Louver Assy 18	Summer/Winter Switch 4
Burner Only 12	Low Ambient Fan Control 6	Swivel Connection 18
Burner Orifices 13	M	T
Burner Rack 12	Manifold 12	Terminal Strip 4
Burner Rack Support 12	Model No. 2	Thermocouple 13
Burner Rack Supports 16	Belt-Driven Motor 8	Thermostat Bracket 5
C	Blower Motor 9	Thermostats 5
Cabinet Parts 16	Blower Motors 10	Stepdown Transformer 6
Capacitor 8, 14, 15	Direct Drive Motor 8	Transformers 5
Carryover 12	Fan Motor 7	V
Circuit Breaker 4	Venter Motor 14	Shut-off Valve 12
Contactor 9, 10	Motor Adjustment Mounting Assy 8	Vent Cap 14, 15, 18
D	Motor Band 8	Vent Damper 5
Date of Manufacture 3	Motor Mounting Bracket 8	Venter 14
Dates of Introduction 3	Motor Support 8	Venter Fan Blade 14
Downturn Nozzle Kit 20	Multiple Heater Control 6	Venter for Gravity-Vent Units 15
Drive 10	N	Venter Gasket 14
Duct Flange 18	Nozzles 20	Venter Motor and Wheel Assembly 14
E	O	Venter Wheel 14
Electrical Components 4	Burner Orifices 12	W
F	Overload 9, 10	Warranty 3
Fan Blades 7	P	
Fan Components 7	Paint 18	
Fan Control 4	Match-Lit Pilot 13	
Fan Guard 7	Spark Pilot 13	
Fan Motor Spacing 7	Pilot Shield 12	
Filters 19	Polytube Adapters 20	
Flame Sensor 13	Pressure Switch 14	
Fuse 4	Blower Pulley 10, 11	
G	Motor Pulley 10, 11	
Gasket Kit 16	R	
Guards 19	Rating Plate 2	
H	References 3	
Hanger Kits 18		
Heat Exchangers 16		

Example of a Rating Plate

REZNOR®
MERCER, PA. USA 16137
MADE IN MEXICO

UNIT HEATER
CATEGORY I
 FOR INDUSTRIAL/COMMERCIAL USE ONLY
 ANSI Z83.8 [**AA**]-[**A**] CSA 2.6 [**AA'**]-[**A'**] UNIT HEATER
MODEL [B] [C]
SERIAL NO.
 [**D**] VOLTS [**D**] PH [**D**] HZ MAXIMUM TOTAL INPUT [**D**] AMPS
TYPE OF GAS: [E]
 ORIFICE SIZE [**F**] DRILL HAS BEEN FACTORY ADJUSTED FOR USE
 AT [**G**] FEET [**H**] METERS OF ALTITUDE.

	SEA LEVEL	ALT. ADJUSTED
NORMAL INPUT	[I]	[J] BTU/HR.
THERMAL OUTPUT CAPACITY	[K]	[L] BTU/HR.
MINIMUM INPUT (-2 MODELS)	[M]	[N] BTU/HR.
NORMAL MANIFOLD PRESSURE		[O] IN.W.C.
MIN. PERMISSIBLE GAS SUPPLY PRESSURE FOR PURPOSE OF INPUT ADJUSTMENT.	[P] IN.W.C.	

CLEARANCES TO COMBUSTIBLE CONSTRUCTION: TOP-[**Q**],
 FLUE CONNECTION-6", LEFT SIDE-18", RIGHT SIDE-18",
 BOTTOM-12" EXCEPT WHEN SUPPLIED WITH OPTIONAL
 DOWNTURN NOZZLE BOTTOM IS 42"
 FOR ALTERNATE INSTALLATIONS USE THE LATEST EDITIONS
 OF THE APPROPRIATE STANDARD LISTED BELOW / INSTALL
 IN ACCORDANCE WITH REQUIREMENTS OF ENFORCING
 AUTHORITIES:
 FOR AIRCRAFT HANGARS USE STANDARD ANSI/NFPA 409
 FOR PARKING STRUCTURES USE STANDARD ANSI/NFPA 88A
 FOR REPAIR GARAGES USE STANDARD ANSI/NFPA 88B
 THIS UNIT IS NOT FOR USE WITH DUCTS.
 THIS UNIT IS NOT FOR USE WITH FILTERS.
 THIS UNIT IS FOR USE WITH NATURAL GAS AND PROPANE. A
 CONVERSION KIT AS SUPPLIED BY THE MANUFACTURER, SHALL
 BE USED TO CONVERT THIS UNIT HEATER TO THE ALTERNATE
 FUEL.

Key to Rating Plate Information:

- B** = Model No. (Size)
- C** = Month and Year of Manufacture
- D** = Volts, Phase, Hertz and Maximum Total Input Amps
- E** = Type of Gas (Natural or Propane)
- F** = Burner Orifice Size
- G and H** = Elevation in Feet and Meters
- I** = Normal Input (BTUH) at Sea Level
- J** = BTUH Input Adjusted for Altitude
- K** = Thermal Output Capacity (BTUH) at Sea Level
- L** = BTUH Output Adjusted for Altitude
- M** = Minimum Input (BTUH) at Sea Level
- N** = BTUH Minimum Input Adjusted for Altitude
- O** = Normal Manifold Pressure (in. w.c.)
- P** = Minimum Gas Supply Pressure (in w.c.)
- Q** = Top Clearance (inches)

Serial No. Explanation

Example:

BMC	94	9B	N	12345
1	2	3	4	5

Key:

- 1** = Date of manufacturer (see table on page 3)
- 2** = Type of Pilot (Refer to Form P-VALVES)
- 3** = Gas Valve (Refer to Form P-VALVES)
- 4** = Type of Gas (N = Natural; L = Propane)
- 5** = Consecutive number of heater made (identification only)

Model No. Suffixes:

- S** = Stainless steel heat exchanger
- 2** = Two-stage gas valve
- E** = Intermittent spark Ignition (NOTE: Spark ignition required on all units effective 8/2008.)
- H** = Factory equipped for high altitude operation (NOTE: A change in 2004 allowing altitude adjustment in the field eliminated the high-altitude factory-equipped options.

Example of a Replacement Parts Tag

Replacement parts tags on unit heaters are for your convenience

in identifying replacement part numbers. Always give the full Model No., Serial No., and Part No. with description when ordering replacement parts.

COMMON REPLACEMENT PARTS FOR:

MODEL:	FE100
SERIAL NUMBER:	BAA65W7N12345
WHEN ORDERING PARTS, ALWAYS GIVE THE FULL MODEL NUMBER AND SERIAL NUMBER.	
Fan or Blower Motor	95548
Fan Blade	41004
Fan Control	123976
Limit Control	45602
Transformer	131988
Pilot.....	97534
Gas Valve	170609
Heat Exchanger.....	102285

WARNING

ALL PARTS ARE FOR USE WITH THE FUEL IDENTIFIED ON THE UNIT RATING PLATE. IF THE UNIT HAS BEEN CONVERTED TO OTHER FUELS, CHECK WITH THE DEALER FOR PROPER FUEL-CARRYING PARTS. INSTALLATION OF IMPROPER PARTS CAN CAUSE DEATH OR INJURY OR PROPERTY LOSS.

First Element of the Serial Number - Date of Manufacture

Year	Jan	Feb	Mar	Apr	May	June	July	Aug	Sept	Oct	Nov	Dec
1988	ANA	ANB	ANC	AND	ANE	ANF	ANG	ANH	ANI	ANJ	ANK	ANL
1989	AOA	AOB	AOC	AOD	AOE	AOF	AOG	AOH	AOI	AOJ	AOK	AOL
1990	APA	APB	APC	APD	APE	APF	APG	APH	API	APJ	APK	APL
1991	AQA	AQB	AQC	AQD	AQE	AQF	AQG	AQH	AQI	AQJ	AQK	AQL
1992	ARA	ARB	ARC	ARD	ARE	ARF	ARG	ARH	ARI	ARJ	ARK	ARL
1993	ASA	ASB	ASC	ASD	ASE	ASF	ASG	ASH	ASI	ASJ	ASK	ASL
1994	ATA	ATB	ATC	ATD	ATE	ATF	ATG	ATH	ATI	ATJ	ATK	ATL
1995	AUA	AUB	AUC	AUD	AUE	AUF	AUG	AUH	AUI	AUJ	AUK	AUL
1996	AVA	AVB	AVC	AVD	AVE	AVF	AVG	AVH	AVI	AVJ	AVK	AVL
1997	AWA	AWB	AWC	AWD	AWE	AWF	AWG	AWH	AWI	AWJ	AWK	AWL
1998	AXA	AXB	AXC	AXD	AXE	AXF	AXG	AXH	AXI	AXJ	AXK	AXL
1999	AYA	AYB	AYC	AYD	AYE	AYF	AYG	AYH	AYI	AYJ	AYK	AYL
2000	AZA	AZB	AZC	AZD	AZE	AZF	AZG	AZH	AZI	AZJ	AZK	AZL
2001	BAA	BAB	BAC	BAD	BAE	BAF	BAG	BAH	BAI	BAJ	BAK	BAL
2002	BBA	BBB	BBC	BBD	BBE	BBF	BBG	BBH	BBI	BBJ	BBK	BBL
2003	BCA	BCB	BCC	BCD	BCE	BCF	BCG	BCH	BCI	BCJ	BCK	BCL
2004	BDA	BDB	BDC	BDD	BDE	BDF	BDG	BDH	BDI	BDJ	BDK	BDL
2005	BEA	BEB	BEC	BED	BEE	BEF	BEG	BEH	BEI	BEJ	BEK	BEL
2006	BFA	BFB	BFC	BFD	BFE	BFF	BFG	BFH	BFI	BFJ	BFK	BFL
2007	BGA	BGB	BGC	BGD	BGE	BGF	BGG	BGH	BGI	BGJ	BGK	BGL
2008	BHA	BHB	BHC	BHD	BHE	BHF	BHG	BHH	BHI	BHJ	BHK	BHL
2009	BIA	BIB	BIC	BID	BIE	BIF	BIG	BIH	BII	BIJ	BIK	BIL
2010	BJA	BJB	BJC	BJD	BJE	BJF	BJG	BJH	BJI	BJJ	BJK	BJL
2011	BKA	BKB	BKC	BKD	BKE	BKF	BKG	BKH	BKI	BKJ	BKK	BKL
2012	BLA	BLB	BLC	BLD	BLE	BLF	BLG	BLH	BLI	BLJ	BLK	BLL
2013	BMA	BMB	BMC	BMD	BME	BMF	BMG	BMH	BMI	BMJ	BMK	BML
2014	BNA	BNB	BNC	BND	BNE	BNF	BNG	BNH	BNI	BNJ	BNK	BNL
2015	BOA	BOB	BOC	BOD	BOE	BOF	BOG	BOH	BOI	BOJ	BOK	BOL
2016	BPA	BPB	BPC	BPD	BPE	BPF	BPG	BPH	BPI	BPJ	BPK	BPL
2017	BQA	BQB	BQC	BQD	BQE	BQF	BQG	BQH	BQI	BQJ	BQK	BQL
2018	BRA	BRB	BRC	BRD	BRE	BRF	BRG	BRH	BRI	BRJ	BRK	BRL
2019	BSA	BSB	BSC	BSD	BSE	BSF	BSG	BSH	BSI	BSJ	BSK	BSL
2020	BTA	BTB	BTC	BTD	BTE	BTF	BTG	BTH	BTI	BTJ	BTK	BTL

Literature References:

All literature is available for viewing or downloading on www.RezSpec.com

Form	Applies to	Installation Instructions for:	Form P/N
I-F/B	F/B	Heater Installation Manual	98126
I-F/B-HV	F/B 250, 300, 400	Horizontal/Vertical Vent Outlet	102860
I-F/B-HV125	F/B125	Horizontal/Vertical Vent Outlet	132794
I-FE/BE	FE/BE	Heater Installation Manual	98807
CP-F/B-GC	F/B/FE/BE	Gas Conversion Kits	99279
CP-F/B-IGN	F/B	Ignition Conversion Kits (match-lit to spark)	100550
I-F/B-PV	F/B	Optional Power Venter	97967
I-F/B-AS	F/B/FE/BE	Optional Air Shutters	98239
I-B-BF	B/BE	Optional Blower Cabinet	99714
I-B-BG	B/BE	Optional Guards	101542
I-B-DF	B/BE	Optional Duct Flange	101192
I-F/B-DN	F/B/FE/BE	Optional Downturn Air Nozzles	97926
I-F/B-LA	F/B/FE/BE	Optional Low Ambient Fan Control Relay	131134
I-B-PF	B/BE	Optional Polytube Adapters for Floor-Level Units	101694
I-B-PS	B/BE	Optional Polytube Adapters for Suspended Units	101500
I-F/B-R	F/FE/B/BE	Optional Relays	98149
I-B-SWB	B/BE	Optional Summer Fan Switch	101678
I-F-SWF	F/FE	Optional Summer Fan Switch	98294
I-F/B-VL	F/FE/B/BE	Optional Vertical Louvers	97925
I-F/B-X	F/FE/B/BE	Optional Stepdown Transformers	102265
P-VALVES	All	Ignition Controllers, Valves, & Serial No. Identification	263995

Dates of Introduction

Model	Introduction
F	AND (4/88)
FE	AND (4/88)
B	ANL (12/88)
BE	ANL (12/88)

Warranty - Models F, FE, B, BE

One-year limited warranty on the heater







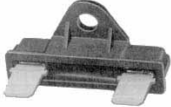

Nine-year extended limited warranty on the heat exchanger, draft hood, flue baffle assembly, flue collection box, and burners

Four-year extended limited warranty on operational parts (except blower belts)





Electrical Components

Code	Description		Size								
			25	50	75/100	125	130/165	200	250	300	400
1	ECO Limit Control*	F/FE	82414, Thermodisc #G4AP0200152C, 152°C								
*Not on any units after 2008. F&B with match-lit pilot have an ECO limit control. FE&BE and F&B with optional spark pilot manufactured prior to 8/99 have an ECO limit control.		B/BE	131450, Thermodisc #G5AP0201152C, 152°C (replaces 82414 on blower heaters)								
2	Limit Control - heaters mfgd beginning 9/96 (Serial No. Date Code AVI)	FE	85449, 200°F			82091, 160°F	85449, 200°F	45602, 180°F			
		F	85449, 200°F		45602, 180°F	82091, 160°F	85449, 200°F	45602, 180°F			
		BE	45602, 180°F			100799, 150°F					
		B	45602, 180°F	85449, 200°F		100799, 150°F					
	Limit Control - heaters mfgd prior to 9/96	FE	85449, 200°F			82091, 160°F	85449, 200°F	45602, 180°F			
		F	85449, 200°F		45602, 180°F	82091, 160°F	85449, 200°F	45602, 180°F			
		BE	45602, 180°F			100799, 150°F					
		B	45602, 180°F			100799, 150°F					
3	Fan Control, Thermodisc #60T12 with Bracket (See NOTE below.)	F/FE	123974, 105/135°F (replaces 96387)	123976, 95/135°F (replaces 114009)			123974, 105/135°F (replaces 96387)				
		B/BE	123975, 95/150°F (replaces 100857)								
4	Summer/Winter Switch Assembly (Same as Option CH1)	F/FE	98484 (Includes switch and wiring)							98485	
		B/BE	101679 (Includes switch, relay, and wiring)								
5	2-Screw Terminal Strip		96041 - for 24V connections								
6	4-Screw Terminal Strip		96511 - for 24V connections								
7	RBM Relay		Units manufactured beginning 9/11, P/N18549 (included in 2-stage control options)								
			For units manufactured before 9/11 (Serial No. Date Code BKI), order Replacement Kit P/N 263527 (Relay is standard in BE & FE and with 2-stg control options.)								
8	Time Delay Relay		--	--	97479, Thermodisc #305048						

NOTE: Temperature settings on the current replacement fan controls are different from the previous models because of a change in construction of the switch. However, these controls are interchangeable and will perform a nearly identical control function.

Code 1 - ECO Device 	Code 2 - Limit Control, Automatic Reset 	Code 3 - Fan Control Assembly 	Code 4 - Summer/Winter Switch 
Code 5 - Two-Screw Terminal Strip Connector, P/N 96041 	Code 6 - Four-Screw Terminal Strip Connector, P/N 96511 	Code 7 - RBM Relay, P/N 18549 	Code 8 - Time Relay Delay, P/N 97479 

Code	Description		Size						
			25	50	75/100	125	130/165/200	250/300/400	
9A	Blocked Vent Switch, Thermodisc #36Tx46, 1/2" Snap Disk, manual reset, 1/4" QC (standard on gravity-vent models beginning April 1991 - Applies to Standard single units only (See Code 9B, Gasket)		112751 - Setting Open @ 200°F #6215	112752 - Setting Open @ 225°F #6217	121275 - Setting Open @ 275°F #6279				
	Blocked Vent Switch, Thermodisc #36Tx46, 1/2" Snap Disk, manual reset, 1/4" QC (standard on gravity-vent models beginning April 1991 - Applies to optional two-stage units only (See Code 9B, Gasket)		--	--	112752 - Setting Open @ 225°F #6217				
9B	Blocked Vent Gasket - for heaters with single-stage controls		--	(2)121341	--	--	--	--	
	Blocked Vent Gasket - for heaters with optional two-stage controls		--	--	(1) 121341	--	(1) 121341	--	
10	Circuit Breaker W58XB1A4A8	(Fusible disconnect	146831						
11	On/Off Switch, McGill 4125-0004	Option A1)	146830						

Code 9A - Blocked Vent Switch 	Code 10 - Circuit Breaker, P/N 146831 	Code 11 - On/Off Switch, P/N 146830 	Code 12 - Fuse and Fuse Holder for Blower Units with Optional 575 Volt Fuse, 2.5 amp, 2501, #3120, P/N 60242 Fuse Holder, Buss HTB-481, P/N 60241 
---	---	---	---

Code 13 - Control Transformers

Description	P/N	Used on Models
115/1/60, 12VA, Basler #BE141615-RAD	131988 (replaces 102706)	F 25-400 Single-Stage, Match-Lit Pilot B 25-300 Single-Stage, Match-Lit Pilot
115/1/60, 20VA, Basler #BE141620-RAD	132204 (replaces 102709)	FE 25-400 Single Stage, Spark Pilot BE 25-300 Single-Stage, Spark Pilot F 25-400 Single Stage, Spark Pilot B 25-300 Single-Stage, Spark Pilot F 75-400 Two-Stage, Match-Lit Pilot B 75-300 Two-Stage, Match-Lit Pilot BE 400 Two-Stage, Spark Pilot B and BE 400 with Optional 575 3ph/60Hertz
115/1/60, 35VA, Basler #BE141640-RAK	102708 (replaces 96507)	F 75-400 Two-Stage, Spark Pilot B 75-300 Two-Stage, Spark Pilot FE 75-300 Two-Stage, Spark Pilot BE 75-300 Two-Stage, Spark Pilot
208/230/1/60; 208/230/3/60; 35VA, Basler #BE21537004	103500 (replaces 96508)	B 400 Single-Stage, Match-Lit Pilot B 400 Two-Stage, Match-Lit Pilot B 400 Single-Stage, Spark Pilot B 400 Two-Stage, Spark Pilot BE 400 Single-Stage, Spark Pilot F 130-400 with Optional 208/230V/1Ph/60 Hertz FE 130-400 with Optional 208/230V/1Ph/60 Hertz B 50-400 with Optional 208/230V/1Ph/60 Hertz BE 50-400 with Optional 208/230V/1Ph/60 Hertz F 25-400 with Optional 230V/1Ph/50 Hertz B 75-400 with Optional 208/230V/3Ph/60 Hertz BE 130-400 with Optional 208/230V/3Ph/60 Hertz B 75-400 with Optional 460V/3Ph/60 Hertz BE 130-400 with Optional 460V/3Ph/60 Hertz
460/3/60, 35VA, Basler #BE641640-RAK	103495 (replaces 96509)	B 75-400 with Optional 460V/3Ph/60 Hertz BE 130-400 with Optional 460V/3Ph/60 Hertz
600/3/60, 1/4 KVA, Type HSD, Primary/120-240V Secondary, Hevi-Duty #10A250	113556	B/BE 130-400 with Optional 575V/3Ph/60 Hertz

Code 13 - Control Transformer



Code 14 - Automatic Vent Damper with 8' Wiring Harness for Model F and B (Same as Option AV7; requires ignition controller with lockout - see Code 16.)



F/B Size	Vent	P/N
25, 50	4"	234005
75	5"	234006
100	6"	234007
125	7"	234008
165, 200	8"	234009
250, 300	10"	234010
400	12"	234011

Ignition Controllers and Conversion Kits

Code 15 - Ignition Controller for Intermittent Spark Pilot System without Lockout, P/N 257009 (Serial No. Code 94)



To replace a previously used recycling ignition controllers without lockout (Serial No. Codes 62 and 66), order Replacement Kit, P/N 257472

Code 16 - Ignition Controller with Lockout, P/N 257010 (Serial No. Code 95)



To replace a previously used ignition controllers with lockout (Serial No. Codes 63, 65 and 84), order Replacement Kit, P/N 257473

Ignition Conversion Kits for Models F & B with Match-Lit Pilot

Model	Fuel	Spark Kit with or without lockout	P/N
F/B 25-165	Natural Gas	without Lockout	100525
F/B 200-250			100526
F 300-400, B 300			100527
B 400	Natural Gas	with Lockout	102348
F/B 25-165			100528
F/B 200-250			100529
F 300-400, B 300			100530
B 400	Propane	with Lockout	102349
F/B 25-200			100531
F 250-400, B 250-300			100532
B 400			102350

Optional Thermostats & Thermostat Bracket

Code 17 - 1-stage, 24 volt, 50-90°F, P/N 255350 (Same as Option CL1)



Code 18 - 2-stage, 24 volt, digital, P/N 220630 (Same as Option CL22)



Code 19 - Thermostat Bracket, Package P/N 98524 (Same as Option CM3)

*Notes:

- 1) Do not increase the length of the coupling.
- 2) Due to possible vibration, do not use mercury switch thermostat with this bracket.

Component Description	P/N
2x4 Electrical Box	17782
1/1" Coupling*	7447
1/2" Threaded Nipple	(2) 3618
Bracket	98353

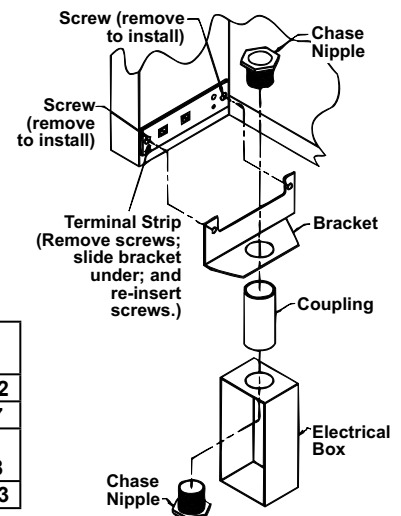

Electrical Components (cont'd)

Code 20 - Low Ambient Fan Control Relay Kit, P/N 113779

Kit Components:		
Qty	P/N	Description
1	114007	Time Delay Relay Assembly (pre-wired consisting of Time Delay Relay Thermodisc #305055, P/N 97479, and four wire assemblies)
2	82485	Screws, #4 x 3/8" long (for attaching relay assy)
1	16354	Wire Nut
1	98117	Open/Closed Bushing



Application: The low ambient fan control relay kit is designed to prevent false cycling of the fan/blower on unit heaters installed in areas with ambient temperature of less than 40°F.

Code 21 - Optional Multiple Heater Control Kits

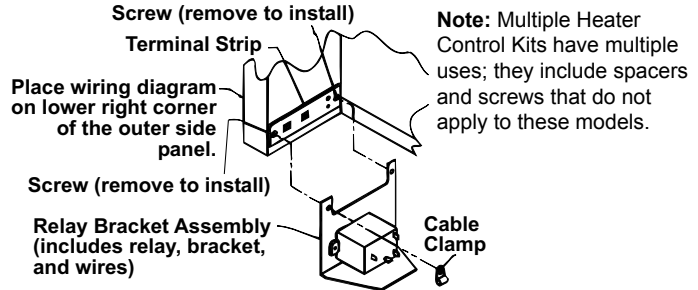

Code 21A - Package P/N 102248 (Same as Option CL31)	Qty	P/N	Component Description
	1	102708	Transformer 35VA- Basler #BE141640-RAK
	2	103152	Sheetmetal Screws, #6 x 1-1/2" lg
	2	111233	Tinnerman Clips, #C1110-62
	2	102243	Relay Assembly (*Relay only P/N 18549)
	2	16228	Cable Clamp
	2	131127	Wiring Diagram Label
Code 21B - Package P/N 102249 (Same as Option CL32)	Qty	P/N	Component Description
	1	102243	Relay Assembly (*Relay only P/N 18549)
	1	16225	Cable Clamp 3/16"
	1	131127	Wiring Diagram Label

* If replacing only relay, P/N 14747 (used prior to 9/2011), order Kit P/N 263527.

Code 22- Optional Stepdown Transformer Kits - All Models F&FE and Models B&BE Sizes 25-100 with Standard Direct Drive Motors



*Option CA1 is a 115 volt power venter.

Option	Voltage	Applies to	P/N by Size	25	50	75	100
CF1	208/115	Model B	Option Pkg	261244	261246	261246	261246
			w/Transformer	260928, .50 KVA	223462, 1.0 KVA	223462, 1.0 KVA	223462, 1.0 KVA
CF2	230/115	Gravity Vent	Option Pkg	102267	102269	102269	102269
			w/Transformer	11100, .50 KVA	16065, 1.0 KVA	16065, 1.0 KVA	16065, 1.0 KVA
CF4	460/115		Option Pkg	102267	102269	102269	102269
			w/Transformer	11100, .50 KVA	16065, 1.0 KVA	16065, 1.0 KVA	16065, 1.0 KVA
CG1	208/115	Model B w/CA1*	Option Pkg	261244	261246	261246	261246
			w/Transformer	260928, .50 KVA	223462, 1.0 KVA	223462, 1.0 KVA	223462, 1.0 KVA
CG2	230/115	Power Vent & Model BE	Option Pkg	102267	102269	102269	102269
			w/Transformer	11100, .50 KVA	16065, 1.0 KVA	16065, 1.0 KVA	16065, 1.0 KVA
CG4	460/115		Option Pkg	102267	102269	102269	102269
			w/Transformer	11100, .50 KVA	16065, 1.0 KVA	16065, 1.0 KVA	16065, 1.0 KVA

Option	Voltage	Applies to	P/N by Size	25	50	75	100	125	165	200	250	300	400
CF1	208/115	Model F	Option Pkg	261243	261243	261243	261243	261243	261244	261244	261244	261244	261246
			w/Transformer	260927, .25 KVA	260927, .25 KVA	260927, .25 KVA	260927, .25 KVA	260928, .50 KVA	260928, .50 KVA	260928, .50 KVA	223462, 1.0 KVA	223462, 1.0 KVA	223462, 1.0 KVA
CF2	230/115	Gravity Vent	Option Pkg	102266	102266	102266	102266	102266	102267	102267	102267	102267	102269
			w/Transformer	11279, .25 KVA	11279, .25 KVA	11279, .25 KVA	11279, .25 KVA	11100, .50 KVA	11100, .50 KVA	11100, .50 KVA	16065, 1.0 KVA	16065, 1.0 KVA	16065, 1.0 KVA
CF4	460/115		Option Pkg	102266	102266	102266	102266	102266	102267	102267	102267	102267	102269
			w/Transformer	11279, .25 KVA	11279, .25 KVA	11279, .25 KVA	11279, .25 KVA	11100, .500 KVA	11100, .500 KVA	11100, .500 KVA	16065, 1.0 KVA	16065, 1.0 KVA	16065, 1.0 KVA
CG1	208/115	Model F with CA1*	Option Pkg	261243	261244	261244	261244	261245	261245	261244	261245	261245	261246
			w/Transformer	260927, .25 KVA	260928, .50 KVA	260928, .50 KVA	260929, .75 KVA	260929, .75 KVA	260929, .75 KVA	260929, .75 KVA	223462, 1.0 KVA	223462, 1.0 KVA	223462, 1.0 KVA
CG2	230/115	Power Vent & Model FE	Option Pkg	102266	102267	102267	102267	102268	102267	102267	102268	102268	102269
			w/Transformer	11279, .25 KVA	11100, .50 KVA	11100, .50 KVA	11217, .75 KVA	11217, .75 KVA	11100, .50 KVA	11217, .75 KVA	16065, 1.0 KVA	16065, 1.0 KVA	16065, 1.0 KVA
CG4	460/115		Option Pkg	102266	102267	102267	102267	102268	102267	102267	102268	102268	102269
			w/Transformer	11279, .25 KVA	11100, .50 KVA	11100, .50 KVA	11217, .75 KVA	11217, .75 KVA	11100, .50 KVA	11217, .75 KVA	16065, 1.0 KVA	16065, 1.0 KVA	16065, 1.0 KVA

Components Common to All Optional Stepdown Transformer Packages Listed in Tables Above

Qty	P/N	Description
1	102261	Bracket Assembly
1	113275	1/2" lg Sheetmetal Screw
1	16247	5/16 x 3/4" lg Hex Head Cap Screw
1	1333	5/16 Lockwasher
2	1087	Flat Washers
1	2039	BX Cable 3/8 x 18" long
1	16202	Straight Connector

Qty	P/N	Description
1	1417	90° Connector
2	16358	Anti-Short Bushings
1	5566	Black Wire, 14 ga x 30" long, 105°C
1	32525	White Wire, 14 ga x 30" long, 105°C
1	102264	Green Wire, 14 ga x 30" long, 105°C
10	16354	Twist-on Wire Connectors

Fan Components -- Models F and FE

Code	Description	Size											
		25	50	75	100	125	130	165	200	250	300	400	
26A	Full Fan Guard (See "Fan Guard Replacement" below.)	110907		110908	110910	132363	110910	136209 (replaces 110911)	110912	176647 (replaces 131404 and 110914)		176648 (replaces 110915 & 131405)	
26B	Fan Guard Plate (2)	--	--	--	--	133977	--	133978	--	176151			
26C	Fan Guard Hardware	(4) 96450 screws w/washers					--	(4) 96450	--	(4) 96450	(8) 113275, #10-32 1/2" lg hex head		
26D	Fan Guard Isolator Assy (4)	--	--	--	--	96451	--	96451	--	96451			
26E	Washer for Code 26D (4)	--	--	--	--	96452	--	96452	--	96452			
27	Motor Adapter Plate	--	--	--	--	96452	--	96452	--	176523			
28	Fan Motor, 115/1/60, Open (NOTE: Replacement 208/230/1/60 fan motor is no longer available.)	96286 Universal JA2C377N	96287 Universal JA2N199N	96288 Universal JA2R238N	95548 1/30HP, A. O. Smith 326P139		95547 1/20HP		95546 1/6HP A.O. Smith F42A51A13		147913 1/4HP A.O. Smith F48H01A13 (replaces 95545)	156275 1/2HP	
	Fan Motor, 115/1/60, Enclosed	96286 Universal JA2C377M	100992 Universal JA2S128N		102380 1/8HP A.O. Smith 322P986			102381 1/6HP A.O. Smith F48G56A13	137044 1/4HP, F48AE65A13 (replaces 115866)		--		
	Fan Motor, 230/1/50 Hertz (Opt AK11) Model F only	112675 Universal JF2K010N			121277 A.O. Smith 92AC154				172794 Assy including motor P/N 155063				
	Fan Motor, .018HP, 115/1, School Option (Opt AL2B) for Model F50 only	--	174403	--	--	--	--	--	--	--	--	--	
29	Fan Blades (For proper shaft placement, see Fan Motor Spacing Table below.)	132465 Revcor 01005-18 (replaces 96377)	129853 Revcor 011005-34 (replaces 96378)	96379 Revcor G1203-30	41004 Lau FP- 1437	131970 Revcor T1603- 32	104692 Revcor T1404-40 (replaces 48692)	96380 Revcor G1603- 40	96381 Lau F10 H8.7 20-24	96382 Lau F10 H8.7 22-26	96383 Lau F10 H8.7 22-36	96384 Lau F-12 H8.7 24-36	
	Fan Blades, 5/16" bore, 10" dia, 5 blades, 34o pitch, School Option (Opt AL2B) for Model F50 only	--	129853	--	--	--	--	--	--	--	--	--	

Model FE illustrating one-piece Fan Guard

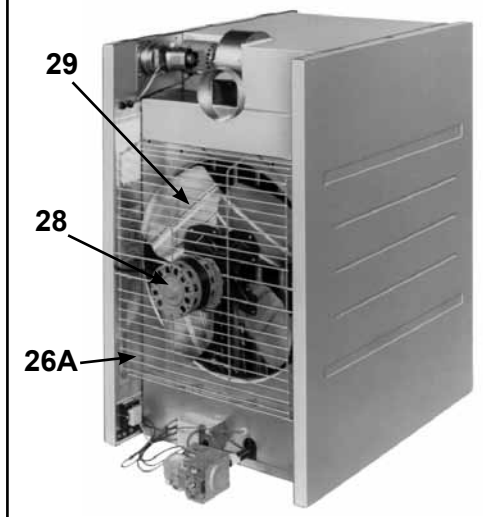

Model	Date of Manufacture	Standard Fan Guard	Was available as an Option
F	4/88 - 10/90	Lower Half only	Upper Half
	After 10/90	One-Piece Full Fan Guard	None
FE	4/88 - 10/89	Lower Half only	Upper Half
	10/89 - 10/90	Both Upper and Lower Halves	None
	After 10/90	One-Piece Full Fan Guard	None

Fan Guard Replacement - The upper and lower fan guard halves are no longer available. If adding an "upper half" or replacing a fan guard, it is necessary to install the full fan guard (Code 26A). To make this replacement, follow these instructions.

1. If the heater is installed, turn off the gas and disconnect the electric power.
2. Remove the left outer side panel (left when facing the rear of the unit). Disconnect the fan motor wires.
3. If present, remove the tension-mounted upper half fan guard.
4. Remove the four screws for attaching the fan guard. Remove the lower half fan guard, the motor, and the fan blade.
5. Assemble the new full fan guard, the motor and the fan blade. To Assure proper grounding of the motor, it is important that the same hardware be used for attaching the motor to the fan guard as was used with the original guard.
Check fan blade position on the shaft; see illustration below and Table left.
Position the assembly on the heater.

Attach the fan guard at the center mounts using the screws that held the old fan guard. (It is important that you use these specially designed screws because they will cut through the coating on the fan guard to provide a ground for the fan motor.)

6. Rotate the fan blade to check for adequate clearance. If adjustment is required, loosen the mounting screws, re-position the fan guard, and tighten the screws. Rotate the fan blade and re-check for adequate clearance. Repeat this procedure until the assembly is positioned properly.
7. Drill the required upper and lower mounting holes. Attach the new fan guard at all upper and lower mounting points using field-supplied sheetmetal screws.
8. Reconnect the fan motor wires and replace the outer side panel.
9. Restore power to the heater and turn on the gas. Light, following the instructions on the lighting instruction plate. Check for proper operation.

Fan Motor Spacing

Size	Electrical Supply	Fan Blade P/N	Set Screw Torque In-Lbs	"A" Hub to Motor Spacing
25	60 Hz	132465	80 ±10	1-1/4"
	50 Hz*			3-1/4"
50	60 Hz	129853	80 ±10	3/8"
	50 Hz*			3-1/4"
75	60 Hz	96379	80 ±10	1/8"
	50 Hz*			3-1/4"
100	50* or 60 Hz	41004	120 ±10	2-1/2"
125		131970		
130		104692		
165		96380	150 ±10	
200		96381		
250		96382		
300		96383		
400	96384			

*Only gravity-vented F models are available with 50 Hz.

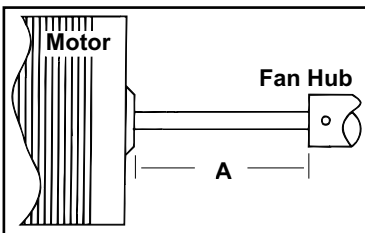

Blower Components - Models B and BE 25-100 with Direct Drive Motor

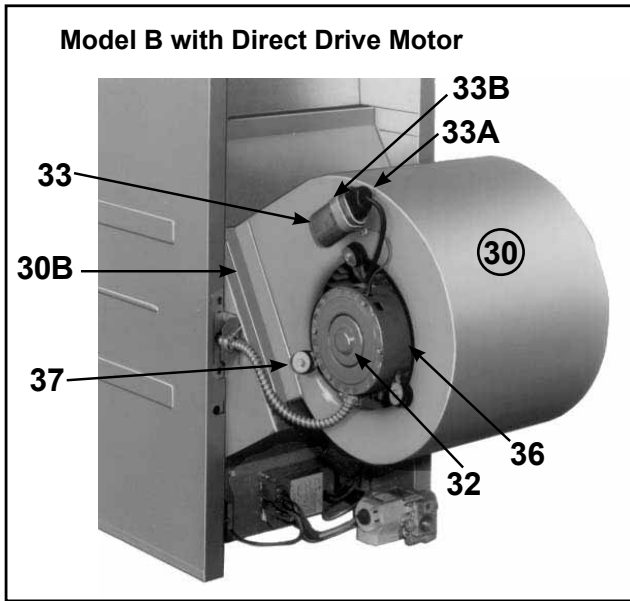

Code	Description	Size			
		25	50	75	100
30	Blower Assy including blower (Code 30A), mounting angle (Code 30B), and restrictors	100897	100898	100899	
30A	Blower only including housing and wheel	82111, Lau #DD9-6AP		43607, Lau #DD9-9AP	
30B	Blower Mounting Angle	100888 (2)			
30C	Restrictor	100891	--	--	--
30D	Restrictor Mounting Angle	100872 (3)	--	--	--
31	Blower Washer 3/4" x 1-1/2"	1087 (4)			
32	Direct Drive Motors, 115 volt	201760, 1/6HP (replaces 100491)		201761, 1/3HP (replaces 100490)	
33	Capacitor	101917, 5MFD/370V (replaces 43614)		101918, 7.5MFD/370V (replaces 82095)	
33A	Capacitor End Cap	82113 (Stone City #4522-07)			
33B	Capacitor Strap Bracket	82114 (Stone City #1614)			
34	Washer 1-1/8" OD x 1/4" ID	82450 (3)			
35	Screw #14x1-1/4" Slotted Hex	82451 (3)			
36	Motor Band	51221			
37	Motor Support	51223 (3)			

Blower Components - Models B and BE 50-400 with Belt-Driven Motor

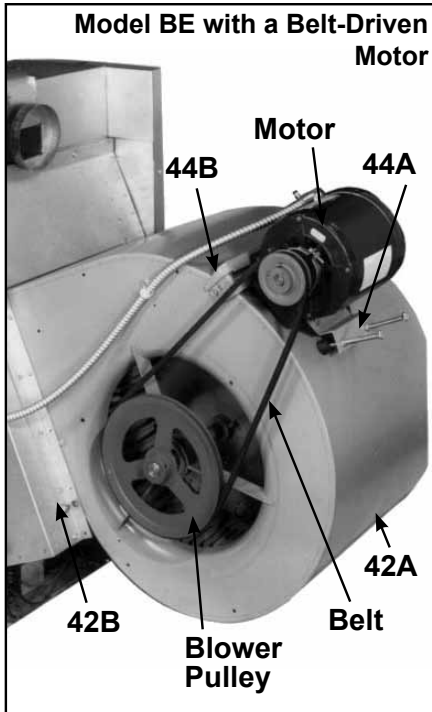

Code 44A - Motor Adjustment Mounting Assy - used with less than 1HP Motor

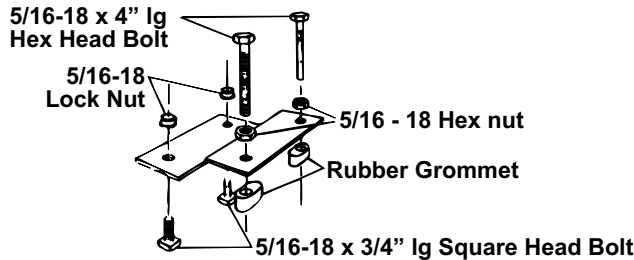

Code 44B - Blower Motor Mounting Bracket

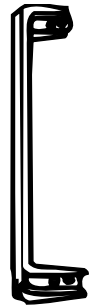

Motor Adjustment Mounting Assy - 1HP and larger motor

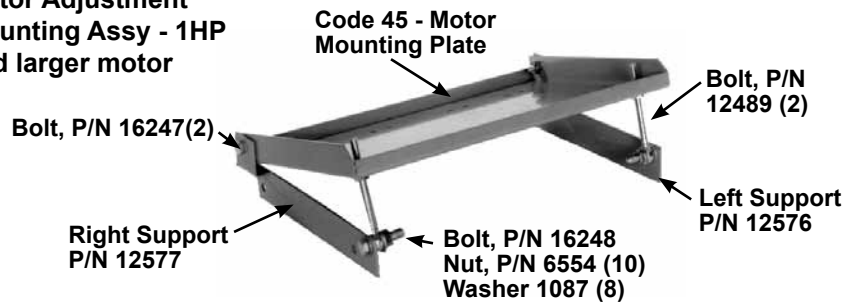

Code	Description	Size							
		50	75	100	125	130/165	200	250/300	400
42A	Blower only	100655, Lau #A9-6ACD	100656, Lau #A9-9A	1357, LAU #10AC-10AC	100657, Lau #A12-9ACD	100658, Lau #A15-11ACD	100659, Lau #A15-15ACD		
42B	Blower Mounting Angle	100888 (2)		131800 (2)	100889 (2)	100890 (2)			
42C	Blower Bearings	7310 (2)				10437 (2)			
43	Blower Washer 3/4" x 1-1/2"	--	--	--	--	1087 (4)			
44A	Mtr Adjustment Mounting Assy - 3/4HP or less	44411							
44B	Blower Mtr Mounting Bracket - 3/4HP or less	102536	102537	44409	102533	102534	102535		
45	Blower Mtr Mounting Plate - 1 HP and larger (plate only, see illustration for additional parts)	--	--	--	--	114545	14205	101422	
46	Key, 1/4" square x 1-1/4" long	16099							

Blower Motor Contactor

Code	Description	Sizes	
		50-300	400
47A	Contactors, 115V, Hartland HCC-3XT01CY (Important Note: If replacing a Gould contactor, order complete contactor assembly including a new enclosure, P/N 95527)	119626 (replaces 93662)	--
	Contactors, 230V, Hartland HCC-3XU01CY (Important Note: If replacing a Gould contactor, order complete contactor assembly including a new enclosure, P/N 95528)	119627 (replaces 93663)	
	Contactors, 460V, 24V Coil, Hartland HCC-3XQ01CY (Important Note: If replacing a Gould contactor, order complete contactor assembly including a new enclosure, P/N 95526)	216386 (replaces 93661 or 119625)	
47B	Contactors Enclosure	93917	
47C	Contactors Enclosure Cover	120302	

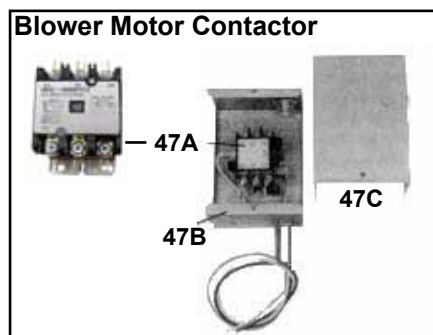

Belt-Driven Blower Motors and Motor Starters

Motors that do not list a contactor and overload have internal overload protection and are used with a contactor (**Code 47A**). Motors in the tables below with a contactor (starter) and overload listed do not have internal overload protection and must be used with the motor starter and overload. All motor starters must be ordered with a NEMA 1 enclosure, **P/N 151207**, GE#CLXE1A.

Type	Motor						Service Factor	Power Factor	Efficiency	Contactor GE #	Reznor® P/N	Overload GE #	o.l. min	o.l. max	Reznor® P/N
	HP	fla	Model No.	P/N	volt	ph									
Open	1/3	6	BF2034	202091	120	1	1.35			-	-	-	-	-	-
	1/3	3	BF2034	202091	208	1	1.35	62.8	61.30%	-	-	-	-	-	-
	1/3	3	BF2034	202091	240	1	1.35	62.8	61.30%	-	-	-	-	-	-
	1/3	1.4	AOS-H260	115863	208	3	1.35			CL00A310T-L	151150	RTA1-G	1.00	1.50	151187
	1/3	1.6	AOS-H260	115863	240	3	1.35			CL00A310T-S	151147	RTA1-H	1.30	1.90	151188
	1/3	0.8	AOS-H260	115863	480	3	1.35			CL00A310T-U	151148	RTA1-F	0.65	1.10	151186
	1/2	8.8	BF2054	102627	120	1	1.15			-	-	-	-	-	-
	1/2	5.1	BF2054	102627	208	1	1.15			-	-	-	-	-	-
	1/2	4.4	BF2054	102627	240	1	1.15			-	-	-	-	-	-
	1/2	2.5	AOS-H880	159183	208	3	1.25			-	-	-	-	-	-
	1/2	3	AOS-H880	159183	240	3	1.25			-	-	-	-	-	-
	1/2	1.5	AOS-H880	159183	480	3	1.25			-	-	-	-	-	-
	1/2		AOS-H991	202089	575	3				Contact distributor or factory.					
	3/4	11	312P629	93548	120	1	1.25			-	-	-	-	-	-
	3/4	6.3	312P629	93548	208	1	1.25			-	-	-	-	-	-
	3/4	5.5	312P629	93548	240	1	1.25			-	-	-	-	-	-
	3/4	2.9	312P696	36951	208	3	1.25			-	-	-	-	-	-
	3/4	2.6	312P696	36951	240	3	1.25			-	-	-	-	-	-
	3/4	1.3	312P696	36951	480	3	1.25			-	-	-	-	-	-
	3/4		AOS-H992	202090	575	3				Contact distributor or factory.					
	1	13	C523	13685	120	1	1.25			-	-	-	-	-	-
	1	7.5	C523	13685	208	1	1.25			-	-	-	-	-	-
	1	6.5	C523	13685	240	1	1.25			-	-	-	-	-	-
	1	4	H882L	36580	208	3	1.15		79%	-	-	-	-	-	-
	1	3.7	H882L	36580	240	3	1.15		79%	-	-	-	-	-	-
	1	2	H882L	36580	480	3	1.15		79%	-	-	-	-	-	-
	1	1.4	AOS-H959	158175	575	3	1.15		82.50%	CL00A310T-Y	151149	RTA1-G	1.00	1.50	151187
	1.5	15	C621	194202	120	1	1.2	86.4	77.20%	-	-	-	-	-	-
	1.5	7.8	C621	194202	208	1	1.2	86.4	77.20%	-	-	-	-	-	-
	1.5	7.5	C621	194202	240	1	1.2	86.4	77.20%	-	-	-	-	-	-
	1.5	5.6	AOS-H884	115859	208	3	1.15	66.4	78.60%	-	-	-	-	-	-
	1.5	5	AOS-H884	115859	240	3	1.15	66.4	78.60%	-	-	-	-	-	-
	1.5	2.8	AOS-H884	115859	480	3	1.15	66.4	78.60%	-	-	-	-	-	-
	1.5	1.6	AOS-H960	158162	575	3	1.15	85.3	86.30%	CL00A310T-Y	151149	RTA1-H	1.30	1.90	151188
	2	10.2	V102	202581	240	1	1.15	81.8	77.50%	-	-	-	-	-	-
	2	7	AOS-H886	159327	208	3	1.15	67	79%	CL00A310T-L	151150	RTA1-M	5.50	8.50	151192
	2	6.6	AOS-H886	159327	240	3	1.15	67	79%	CL00A310T-S	151147	RTA1-L	4.00	6.30	151191
	2	3.5	AOS-H886	159327	480	3	1.15	67	79%	CL00A310T-U	151148	RTA1-K	2.50	4.10	151190
	2	2.1	AOS-H965V1	158176	575	3	1.15	86	84.80%	CL00A310T-Y	151149	RTA1-J	1.90	2.70	151189
	3	9	AOS-H845	159185	208	3	1.15			CL00A310T-L	151150	RTA1-M	5.50	8.50	151192
3	8.6	AOS-H845	159185	240	3	1.15			CL00A310T-S	151147	RTA1-M	5.50	8.50	151192	
3	4.3	AOS-H845	159185	480	3	1.15			CL00A310T-1	151275	RTA1-K	2.50	4.10	151190	
3	3.6	AOS-H954	120019	575	3	1.15	80.3	83.80%	CL00A310T-Y	151149	RTA1-K	2.50	4.10	151190	
5	13.4	196033	113371	208	3	1.15	87.2	85%	CL01A310T-L	151155	RTA1-P	10.00	16.00	151194	
5	13.2	196033	113371	240	3	1.15	87.2	85%	CL01A310T-S	151152	RTA1-P	10.00	16.00	151194	
5	6.6	196033	113371	480	3	1.15	87.2	85%	CL00A310T-1	151275	RTA1-M	5.50	8.50	151192	
5	5.4	H956	120020	575	3	1.15	85.9	85.30%	CL00A310T-Y	151149	RTA1-L	4.00	6.30	151191	
TEFC	1/3	4.6	Stock #906	115861	120	1	1	68.5	72.10%	-	-	-	-	-	-
TEFC	1/3	2.3	C151	159501	208	1	1	67.2	69.50%	-	-	-	-	-	-
TEFC	1/3	2.4	C151	159501	240	1	1	67.2	69.50%	-	-	-	-	-	-

Belt-Driven Blower Motors and Motor Starters (cont'd)

Type	Motor						Service Factor	Power Factor	Efficiency	Contactor	Reznor®	Overload	o.l.		Reznor®
	HP	fla	Model No.	P/N	volt	ph				GE #	P/N	GE #	min	max	P/N
TEFC	1/3	1.2	H261	105567	208	3	1.15		79.50%	CL00A310T-L	151150	RTA1-G	1.00	1.50	151187
	1/3	1.2	H261	105567	240	3	1.15		79.50%	CL00A310T-S	151147	RTA1-G	1.00	1.50	151187
	1/3	0.6	H261	105567	480	3	1.15		79.50%	CL00A310T-U	151148	RTA1-D	0.40	0.65	151184
	1/2	7.2	C613	159184	120	1	1.15			-	-	-	-	-	-
	1/2	3.5	C613	159184	208	1	1.15			-	-	-	-	-	-
	1/2	3.6	C613	159184	240	1	1.15			-	-	-	-	-	-
	1/2	2.3	H274	16077	208	3	1	59.5	74.80%	-	-	-	-	-	-
	1/2	2	H274	16077	240	3	1	59.5	74.80%	-	-	-	-	-	-
	1/2	1	H274	16077	480	3	1	59.5	74.80%	-	-	-	-	-	-
	1/2	0.7	H276	105568	575	3	1.15	76.4	77%	Contact distributor or factory.					
	3/4	11	F353	115860	120	1	1	66	65.70%	-	-	-	-	-	-
	3/4	5.4	F353	115860	208	1	1	66	65.70%	-	-	-	-	-	-
	3/4	5.5	F353	115860	240	1	1	66	65.70%	-	-	-	-	-	-
	3/4	2	H580	20371	208	3	1	73.5	81.10%	-	-	-	-	-	-
	3/4	2.2	H580	20371	240	3	1	73.5	81.10%	-	-	-	-	-	-
	3/4	1.1	H580	20371	480	3	1	73.5	81.10%	-	-	-	-	-	-
	3/4	0.8	H461	105569	575	3	1.15	78.3	82%	Contact distributor or factory.					
	1	12	159105	174993	120	1	1.15	74.3	70.60%	-	-	-	-	-	-
	1	6.2	159105	174993	208	1	1.15	74.3	70.60%	-	-	-	-	-	-
	1	6	159105	174993	240	1	1.15	74.3	70.60%	-	-	-	-	-	-
	1	3.3	WEG-00118ES3ED56	271444	208	3	1	74.4	80.20%	CL00A310T-L	151150	RTA1-K	2.50	4.10	151190
	1	3.4	WEG-00118ES3ED56	271444	240	3	1	74.4	80.20%	CL00A310T-S	151147	RTA1-K	2.50	4.10	151190
	1	1.7	WEG-00118ES3ED56	271444	480	3	1	74.4	80.20%	CL00A310T-U	151148	RTA1-H	1.30	1.90	151188
	1	1.4	H525	105570	575	3	1.15	71.6	80.40%	CL00A310T-J	151146	RTA1-G	1.00	1.50	151187
	1.5	16.4	311P402	94347	120	1				-	-	-	-	-	-
	1.5	9.5	311P402	94347	208	1				-	-	-	-	-	-
	1.5	8.2	311P402	94347	240	1				-	-	-	-	-	-
	1.5	4.3	WEG-00158ES3ED56	271445	208	3	1	80.9	82.40%	CL00A310T-L	151150	RTA1-L	4.00	6.30	151191
	1.5	4.4	WEG-00158ES3ED56	271445	240	3	1	80.9	82.40%	CL00A310T-S	151147	RTA1-L	4.00	6.30	151191
	1.5	2.2	WEG-00158ES3ED56	271445	480	3	1	80.9	82.40%	CL00A310T-U	151148	RTA1-J	1.90	2.70	151189
	1.5	1.7	AOS T59027	105665	575	3	1.15	85.7	84%	CL00A310T-J	151146	RTA1-H	1.30	1.90	151188
	2	12	K200	105572	240	1	1	76.4	75.70%	CL01A310T-S	151152	RTA1-P	10.00	16.00	151194
	2	6.1	WEST NP0024	158165	208	3	1.15	77.5	84%	CL00A310T-L	151150	RTA1-M	5.50	8.50	151192
	2	5.6	WEST NP0024	158165	240	3	1.15	77.5	84%	CL00A310T-S	151147	RTA1-L	4.00	6.30	151191
	2	2.8	WEST NP0024	158165	480	3	1.15	77.5	84%	CL00A310T-1	151275	RTA1-K	2.50	4.10	151190
	2	2.2	AOS T59028	158166	575	3	1.15	77.5	84%	CL00A310T-J	151146	RTA1-J	1.90	2.70	151189
	3	7.7	BALDOR EM3559T	159330	208	3	1.15		85.50%	CL00A310T-L	151150	RTA1-M	5.50	8.50	151192
	3	7	BALDOR EM3559T	159330	240	3	1.15		85.50%	CL00A310T-S	151147	RTA1-M	5.50	8.50	151192
	3	3.5	BALDOR EM3559T	159330	480	3	1.15		85.50%	CL00A310T-1	151275	RTA1-K	2.50	4.10	151190
	3	3	B-M3559T-5	111571	575	3	1.15		85.50%	CL00A310T-J	151146	RTA1-K	2.50	4.10	151190

Belt Drive Components

NOTE: Pulleys require keyseats, see **Code 46**, page 8.

Key to AK Nos.			
Option AK	Voltage	Option AK	Voltage
1	115/1	6	230/3
2	208/1	7	460/3
3	230/1	8	575/3
5	208/3		

Key to AM Nos.			
Option AM	RPM Range	Option AM	RPM Range
2	451-500	8	751-800
3	501-550	9	801-850
4	551-600	10	851-900
5	601-650	11	901-950
6	651-700	12	951-1000
7	701-750		

Open Motor		Voltage AK Opt	Drive AM Option	Motor Pulley			Blower Pulley			Belt Type & Average Length*
HP	AL Opt	(See Key, above.)	(See Key, above.)	P/N	Model	Bore	P/N	Model	Bore	
1/4, 1/3	2, 3	AK1, AK2, AK3, AK5, AK6, AK7	1, 2	4074	1VL34	1/2	111609	AK 99	1	"A-section" 3.8 ft
			3, 4	13491	1VL40	1/2	111609	AK 99	1	"A-section" 3.8 ft
			5, 6, 7	13491	1VL40	1/2	19111	AK 84	1	"A-section" 3.8 ft
			8, 9, 10, 11, 12	13491	1VL40	1/2	18797	AK 64	1	"A-section" 3.8 ft
			13, 14, 15, 16, 17	13491	1VL40	1/2	135200	AK 51	1	"A-section" 3.8 ft
1/2, 3/4, 1, 1-1/2	4, 5, 6, 7	AK1, AK2, AK3, AK5, AK6, AK7	1, 2	13580	1VL34	5/8	111609	AK 99	1	"A-section" 3.8 ft
			3, 4	7962	1VL40	5/8	111609	AK 99	1	"A-section" 3.8 ft
			5, 6, 7	7962	1VL40	5/8	19111	AK 84	1	"A-section" 3.8 ft

Open Motor (cont'd)		Voltage AK Opt	Drive AM Option	Motor Pulley			Blower Pulley			Belt Type & Average Length*
HP	AL Opt	(See Key, page 10.)	(See Key, page 10.)	P/N	Model	Bore	P/N	Model	Bore	
1/2, 3/4, 1, 1 1/2	4, 5, 6, 7	AK1, AK2, AK3, AK5, AK6, AK7	8, 9, 10, 11, 12	7962	1VL40	5/8	18797	AK 64	1	"A-section" 3.8 ft
			13, 14, 15, 16, 17	7962	1VL40	5/8	135200	AK 51	1	"A-section" 3.8 ft
1/2, 3/4	4, 5	AK8	1, 2	13580	1VL34	5/8	111609	AK 99	1	"A-section" 3.8 ft
			3, 4	7962	1VL40	5/8	111609	AK 99	1	"A-section" 3.8 ft
			5, 6, 7	7962	1VL40	5/8	19111	AK 84	1	"A-section" 3.8 ft
			8, 9, 10, 11, 12	7962	1VL40	5/8	18797	AK 64	1	"A-section" 3.8 ft
			13, 14, 15, 16, 17	7962	1VL40	5/8	135200	AK 51	1	"A-section" 3.8 ft
1, 1-1/2	6, 7	AK8	1, 2	110125	1VP34	7/8	111609	AK 99	1	"A-section" 3.8 ft
			3, 4	106748	1VL40	7/8	111609	AK 99	1	"A-section" 3.8 ft
			5, 6, 7	106748	1VL40	7/8	19111	AK 84	1	"A-section" 3.8 ft
			8, 9, 10, 11, 12	106748	1VL40	7/8	18797	AK 64	1	"A-section" 3.8 ft
			13, 14, 15, 16, 17	106748	1VL40	7/8	135200	AK 51	1	"A-section" 3.8 ft
2	8	AK1, AK2, AK3	1, 2	13580	1VL34	5/8	111609	AK 99	1	"A-section" 3.8 ft
			3, 4	7962	1VL40	5/8	111609	AK 99	1	"A-section" 3.8 ft
			5, 6, 7	7962	1VL40	5/8	19111	AK 84	1	"A-section" 3.8 ft
			8, 9, 10, 11, 12	7962	1VL40	5/8	18797	AK 64	1	"A-section" 3.8 ft
			13, 14, 15, 16, 17	7962	1VL40	5/8	135200	AK 51	1	"A-section" 3.8 ft
		AK5, AK6, AK7, AK8	1, 2	110125	1VP34	7/8	111609	AK 99	1	"A-section" 3.8 ft
			3, 4	106748	1VL40	7/8	111609	AK 99	1	"A-section" 3.8 ft
			5, 6, 7	106748	1VL40	7/8	19111	AK 84	1	"A-section" 3.8 ft
			8, 9, 10, 11, 12	106748	1VL40	7/8	18797	AK 64	1	"A-section" 3.8 ft
			13, 14, 15, 16, 17	106748	1VL40	7/8	135200	AK 51	1	"A-section" 3.8 ft
3	9	AK2, AK3	9, 10, 11, 12	7962	1VL40	5/8	202652	AK124	1	"A-section" 3.8 ft
			13, 14, 15, 16, 17	7962	1VL40	5/8	202653	AK94	1	"A-section" 3.8 ft
3, 5	9, 10	AK5, AK6, AK7, AK8	9, 10, 11, 12	106748	1VL40	7/8	101414	BK130	1	"B-section" 3.8 ft
			13, 14, 15, 16, 17	106748	1VL40	7/8	202654	BK105	1	"B-section" 3.8 ft

* Assume 17 Fenner belt links per foot. One "A" belt link is P/N 201809. "B" link is P/N 202655.

TEFC Motor		Voltage AK Opt	Drive AM Option	Motor Pulley			Blower Pulley			Belt Type & Average Length*
HP	AL Opt	(See Key, page 10.)	(See Key, page 10.)	P/N	Model	Bore	P/N	Model	Bore	
1/4	19	AK1	1, 2	4074	1VL34	1/2	111609	AK 99	1	"A-section" 3.8 ft
			3, 4	13491	1VL40	1/2	111609	AK 99	1	"A-section" 3.8 ft
			5, 6, 7	13491	1VL40	1/2	19111	AK 84	1	"A-section" 3.8 ft
			8, 9, 10, 11, 12	13491	1VL40	1/2	18797	AK 64	1	"A-section" 3.8 ft
			13, 14, 15, 16, 17	13491	1VL40	1/2	135200	AK 51	1	"A-section" 3.8 ft
		AK2, AK3, AK5, AK6, AK7	1, 2	13580	1VL34	5/8	111609	AK 99	1	"A-section" 3.8 ft
			3, 4	7962	1VL40	5/8	111609	AK 99	1	"A-section" 3.8 ft
			5, 6, 7	7962	1VL40	5/8	19111	AK 84	1	"A-section" 3.8 ft
			8, 9, 10, 11, 12	7962	1VL40	5/8	18797	AK 64	1	"A-section" 3.8 ft
			13, 14, 15, 16, 17	7962	1VL40	5/8	135200	AK 51	1	"A-section" 3.8 ft
1/3	20	AK1, AK2, AK3, AK5, AK6, AK7	1, 2	4074	1VL34	1/2	111609	AK 99	1	"A-section" 3.8 ft
			3, 4	13491	1VL40	1/2	111609	AK 99	1	"A-section" 3.8 ft
			5, 6, 7	13491	1VL40	1/2	19111	AK 84	1	"A-section" 3.8 ft
			8, 9, 10, 11, 12	13491	1VL40	1/2	18797	AK 64	1	"A-section" 3.8 ft
			13, 14, 15, 16, 17	13491	1VL40	1/2	135200	AK 51	1	"A-section" 3.8 ft
1/2, 3/4, 1	21, 22, 23	AK1, AK2, AK3, AK5, AK6, AK7, AK8	1, 2	13580	1VL34	5/8	111609	AK 99	1	"A-section" 3.8 ft
			3, 4	7962	1VL40	5/8	111609	AK 99	1	"A-section" 3.8 ft
			5, 6, 7	7962	1VL40	5/8	19111	AK 84	1	"A-section" 3.8 ft
			8, 9, 10, 11, 12	7962	1VL40	5/8	18797	AK 64	1	"A-section" 3.8 ft
			13, 14, 15, 16, 17	7962	1VL40	5/8	135200	AK 51	1	"A-section" 3.8 ft
1-1/2	24	AK1, AK2, AK3, AK5, AK6, AK7	1, 2	13580	1VL34	5/8	111609	AK 99	1	"A-section" 3.8 ft
			3, 4	7962	1VL40	5/8	111609	AK 99	1	"A-section" 3.8 ft
			5, 6, 7	7962	1VL40	5/8	19111	AK 84	1	"A-section" 3.8 ft
			8, 9, 10, 11, 12	7962	1VL40	5/8	18797	AK 64	1	"A-section" 3.8 ft
			13, 14, 15, 16, 17	7962	1VL40	5/8	135200	AK 51	1	"A-section" 3.8 ft
		AK8	1, 2	110125	1VP34	7/8	111609	AK 99	1	"A-section" 3.8 ft
			3, 4	106748	1VL40	7/8	111609	AK 99	1	"A-section" 3.8 ft
			5, 6, 7	106748	1VL40	7/8	19111	AK 84	1	"A-section" 3.8 ft
			8, 9, 10, 11, 12	106748	1VL40	7/8	18797	AK 64	1	"A-section" 3.8 ft
			13, 14, 15, 16, 17	106748	1VL40	7/8	135200	AK 51	1	"A-section" 3.8 ft
2	25	AK5, AK6, AK7, AK8	1, 2	110125	1VP34	7/8	111609	AK 99	1	"A-section" 3.8 ft
			3, 4	106748	1VL40	7/8	111609	AK 99	1	"A-section" 3.8 ft
			5, 6, 7	106748	1VL40	7/8	19111	AK 84	1	"A-section" 3.8 ft
			8, 9, 10, 11, 12	106748	1VL40	7/8	18797	AK 64	1	"A-section" 3.8 ft
			13, 14, 15, 16, 17	106748	1VL40	7/8	135200	AK 51	1	"A-section" 3.8 ft
3	26	AK5, AK6, AK7, AK8	9, 10, 11, 12	106748	1VL40	7/8	101414	BK130	1	"B-section" 3.8 ft
			13, 14, 15, 16, 17	106748	1VL40	7/8	202654	BK105	1	"B-section" 3.8 ft

* Assume 17 Fenner belt links per foot. One "A" belt link is P/N 201809. One "B" link is P/N 202655.

Burner Rack and Components

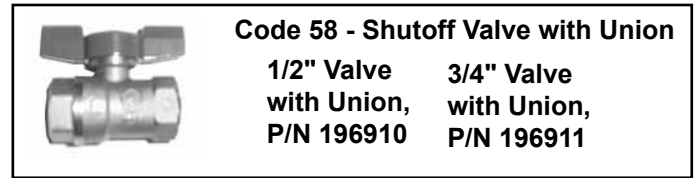
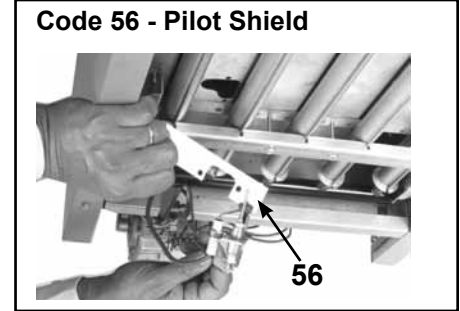
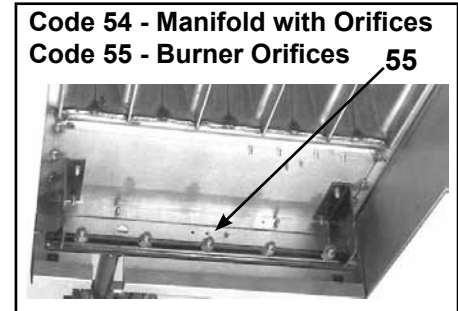
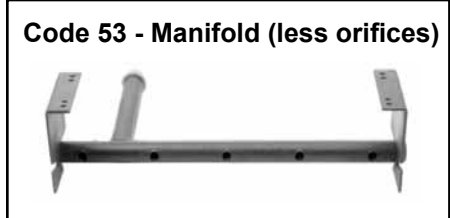
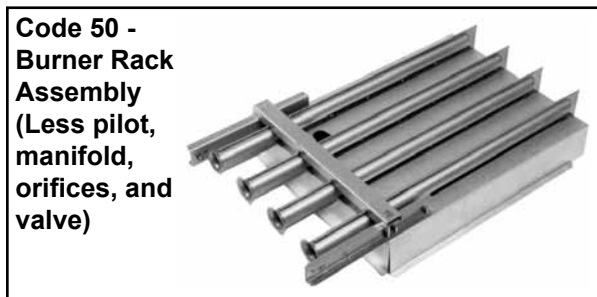

Code	Description	Size										
		25	50	75	100	125	130	165	200	250	300	400
50	Burner Rack Assembly - Aluminized (includes burners and flash carryover; less pilot; less manifold & orifices; and less valve)	98983	98984	98985	98986	132753	98987	98988	98989	98990	98991	98992
	Burner Rack Assembly - Stainless Steel (includes burners and flash carryover; less pilot; less manifold & orifices; and less valve)	98993	98994	98995	98996	132755	98997	98998	98999	99000	99001	99002
50A	Burner only - Aluminized (qty of burners per Size in parenthesis)	94777					94781					
	Burner only - Stainless Steel (qty of burners per Size in parenthesis)	(2)	(3)	(4)	(5)	(6)	(4)	(5)	(6)	(8)	(9)	(12)
51	Carryover Assembly	96769	47690	63128	96042	96044	96043	96042	96044	--	--	--
51A	Right Carryover Assembly	--	--	--	--	--	--	--	--	96045	96046	96045
51B	Left Carryover Assembly	--	--	--	--	--	--	--	--	96047	96047	96047
51C	Center Carryover Assembly	--	--	--	--	--	--	--	--	--	--	63156
52	Burner Rack Support	113936 (See illustration Code 111, page 16.)									113937	
53	Manifold only, less orifices, less valve	95434	95435	95436	95437	95440	95436	95437	95440	95441	95442	95443
54	Manifold with Natural Gas Burner Orifices for sea level* operation (less valve)	99003	99004	99005	99006	132749	99007	99008	99009	99010	99011	99012
	Manifold with Propane Gas Burner Orifices for sea level* operation (less valve)	99013	99014	99015	99016	132751	99017	99018	99019	99020	99021	99022
55	Burner Orifices	See chart on page 13.										
56	Pilot Shield (FE and BE Models and F and B Models with optional spark pilot)	97204										
57	Air Shutter Assembly (Same as Option ED1)	98476	98477	98478	98479	98480	98478	98479	98480	98481	98482	98483
58	Shut-off Valve with Union (Same as CE Option)	196910 - 1/2"										
		--	--	--	--	--	--	--	--	--	--	196911 - 3/4"

* A manifold with "sea level" orifices also applies if the manifold pressure has been adjusted in the field for high altitude operation (check for manifold adjustment label). If the heater was factory equipped for high altitude operation (Option AB), select high altitude orifices separately from the chart on page 13. Check the heater rating plate to identify the elevation at which the heater was manufactured to operate.



Code 55 - Burner Orifices

Description	Size										
	25	50	75	100	125	130	165	200	250	300	400
Burner Orifices (quantity in parenthesis)	Use extreme care in selecting replacement burner orifices										
	(2)	(3)	(4)	(5)	(6)	(4)	(5)	(6)	(8)	(9)	(12)
Natural Gas Orifices for a unit with a rating plate indicating sea level operation (0-2000 ft) even if the manifold pressure has been adjusted for high altitude - U.S.A. & Canada	39650 #51	84853 #47	38678 #45	11833 #44 #44		#35	#35	#35	11831 #35 #35 #35 #35		
Propane Orifices for a unit with rating plate indicating sea level operation (0-2000 ft) even if the manifold pressure has been adjusted for high altitude operation - U.S.A. & Canada	95936 #60	63003 #1.2MM	64676 #1.3MM	11830 #55 #55		#1.65MM	#1.65MM	#1.65MM	96344 #1.65MM #1.65MM #1.65MM		
Orifices for factory-equipped (Option AB) high altitude (check the rating plate)											
2001-4500 ft, Natural Gas - Canada	51284 #52	39651 #49	84853 #47	38678 #45 #45		#37	#37	#37	11835 #37 #37 #37		
2001-4500 ft, Propane - Canada	97534 #62	63922 #1.15MM	97359 #1.25MM	11830 #55 #55		#1.55MM	#1.55MM	#1.55MM	61653 #1.55MM #1.55MM #1.55MM		
2001-3000 ft, Natural Gas - U.S.A.	39650 #51	40414 #48	16590 #46	38678 #45 #45		#36	#36	#36	97362 #36 #36 #36		
2001-3000 ft, Propane - U.S.A.	97355 #61	39658 #56	97359 #1.25MM	11830 #55 #55		#52	#52	#52	51284 #52 #52 #52		
3001-4000 ft, Natural Gas - U.S.A.	51284 #52	40414 #48	84853 #47	38678 #45 #45		#36	#36	#36	97362 #36 #36 #36		
3001-4000 ft, Propane - U.S.A.	97355 #61	63922 #1.15MM	97359 #1.25MM	11830 #55 #55		#1.55MM	#1.55MM	#1.55MM	61653 #1.55MM #1.55MM #1.55MM		
NOTE: All power vented models over 4000 ft also require high altitude venter pressure switch; see Code 75, page 14.)											
4001-5000 ft, Natural Gas - U.S.A.	51284 #52	39651 #49	84853 #47	38678 #45 #45		#37	#37	#37	11835 #37 #37 #37		
4001-5000 ft, Propane - U.S.A.	97354 #62	63922 #1.15MM	97359 #1.25MM	11830 #55 #55		#1.55MM	#1.55MM	#1.55MM	61653 #1.55MM #1.55MM #1.55MM		
5001-6000 ft, Natural Gas - U.S.A.	51284 #52	39651 #49	84853 #47	16590 #46 #46		#37	#37	#37	11835 #37 #37 #37		
5001-6000 ft, Propane - U.S.A.	40415 #63	63922 #1.15MM	63003 #1.2MM	39658 #56 #56		#53	#53	#53	9789 #53 #53 #53		
6001-7000 ft, Natural Gas - U.S.A.	51284 #52	39651 #49	40414 #48	84853 #47 #47		#38	#38	#38	45870 #38 #38 #38		
6001-7000 ft, Propane - U.S.A.	40415 #63	40416 #57	63003 #1.2MM	39658 #56 #56		#53	#53	#53	9789 #53 #53 #53		
7001-8000 ft, Natural Gas - U.S.A.	9789 #53	39652 #50	40414 #48	84853 #47 #47		#39	#39	#39	45871 #39 #39 #39		
7001-8000 ft, Propane - U.S.A.	97352 #64	40416 #57	63922 #1.15MM	39658 #56 #56		#53	#53	#53	9789 #53 #53 #53		
8001-9000 ft, Natural Gas - U.S.A.	9789 #53	39652 #50	39651 #49	40414 #48 #48		#40	#40	#40	87391 #40 #40 #40		
8001-9000 ft, Propane - U.S.A.	97352 #64	40416 #57	63922 #1.15MM	39658 #56 #56		#1.45MM	#1.45MM	#1.45MM	61652 #1.45MM #1.45MM #1.45MM		

<p>60 - Match-Lit Pilot P/N 110851 - Complete replacement pilot for natural gas, match lit pilot (includes Code 60 for natural gas and Code 61)</p>  <p>P/N 110852 - Complete replacement pilot for propane gas, match lit pilot (includes Code 60 for propane and Code 61)</p>			<p>62 - Spark Pilot P/N 110853 - Complete replacement pilot kit for natural gas, spark pilot (includes Code 62 for natural gas, Code 63, and Code 64)</p>  <p>P/N 110854 - Complete replacement pilot kit for propane gas, spark pilot (includes Code 62 for propane gas, Code 63, and Code 64)</p>		
Code	P/N	Component Description	Code	P/N	Component Description
60	96360	Pilot Assembly, Natural Gas, with orifice, pilot tubing, thermocouple, and one compression fitting - Johnson #J994HKA-9731-715	62	97534	Pilot Assembly, Natural Gas, with orifice, pilot tubing, flame rod, and one compression fitting (does not include flame sensor lead) - Johnson #J982HKW-9731-715
	96361	Pilot Assembly, Propane Gas, with orifice, pilot tubing, thermocouple, and one compression fitting - Johnson #J994HKA-9733-410		97535	Pilot Assembly, Propane Gas, with orifice, pilot tubing, flame rod, and one compression fitting (does not include flame sensor lead) - Johnson #J982HKW-9733-410
60A	103034	Orifice only, Natural Gas, Johnson #9731-715 (brass)	62A	103034	Orifice only, Natural Gas, Johnson #9731-715 (brass)
	98695	Orifice only, Propane Gas, Johnson #9733-410 (black)		98695	Orifice only, Propane Gas, Johnson #9733-410 (black)
60B	98698	Pilot Tubing, Johnson #B10499-995-11, 1/8" ODx18"lg	62B	98698	Pilot Tubing, Johnson #B10499-995-11, 1/8" ODx18" lg
61	97572	Compression Fitting, #FTG75	63	97572	Compression Fitting, #FTG75
60C	84761	Thermocouple, 24", #K15FA-24D	62C	98697	Flame Rod, Johnson #Y75AA-3
<p>NOTE: Match-Lit Pilots were used on Model F and B units with heater serial number safety pilot Code 31 (See page 2). (Match-lit pilots were discontinued on heaters manufactured beginning 8/2008.</p>			<p>NOTE: Spark Pilots are used on Model FE & BE units and Model F & B units with heater serial number safety pilot Codes 65, 66, 94, 95 (page 2).</p>		

Venters - Models FE and BE

Code	Description	Size								
		25/50/75	100	125	130	165/200/250	300	400		
70	Venter Housing, DeStaco	98172		131985	98173	101052		98175		
		#250C with 4" Collar		#250C w/5" Collar	#350C w/4" Collar	#350C w/5" Collar	#350C w/6" Collar (Order Venter Gasket, Code 71, with housing for Sizes 125-400)			
71	Venter Gasket	--	--	97300 (must be ordered when replacing Code 70 on Sizes 125-400)						
72	Venter Motor and Wheel Assembly by supply voltage (less pressure switch and tubing)	115/1	FE	97727	131986	97730			--	
			BE	97727	131986	97730			--	
		208/1	FE/BE	--	--	133244	98369			--
			FE	--	116102	133244	98369			--
		230/1	BE	--	--	--	98369			--
			208/3	BE	--	--	--	98369	98369	98369
		230/3	BE	--	--	--	98369	98369	98369	98369
		460/3	BE	--	--	--	116280	116280	116280	116280
575/3	BE	--	--	--	97730	97730	97730	97730		
72A	Venter Motor Only (by supply voltage)	115/1	FE	148055, Magnetek JA1M213 (replaces 97738)		165700, McMillan #229396/1 (replaces 148053 and 97741)			--	
			BE	148055, Magnetek JA1M213 (replaces 97738)		148053, Magnetek JE1E024 (replaces 97741)			--	
		208/1	FE/BE	--	--	148054, Magnetek JE1E025 (replaces 98157)				
			FE	--	--	148054 (replaces 98157), Magnetek JE1E025				
		230/1	BE	--	--	148054 (replaces 98157), Magnetek JE1E025				
			208/3	BE	--	--	148054 (replaces 98157), Magnetek JE1E025			
		230/3	BE	--	--	148054 (replaces 98157), Magnetek JE1E025				
		460/3	BE	--	--	115802, Fasco #7162-3388				
575/3	BE	--	--	148053 (replaces 97741), Magnetek JE1E024						
72B	Venter Wheel Only	97725, Beckett #12063		131987, Beckett V325-2035	97724, Brookside #FE400-200-2					
72C	Motor Plate (not illustrated)	68007			93701					
72D	Venter Fan Blade, 2-1/2"	68005								

Venter Assembly

Code 71 - Venter Gasket, P/N 97300

Code 72 - Venter Motor and Wheel Assembly 72B

Code 72D - Venter Fan Blade, P/N 68005

Code 73 - Capacitor, P/N 163894

Code 76 - Sensing Tube Assembly
Used on heaters mfgd prior to 1/94. Used on heaters mfgd beginning 1/94.

Code 77 - Silicone Tubing - Two pieces required on heaters manufactured prior to 1/94; one piece required on heaters manufactured beginning 1/94.

Code 79 - RBM Relay, P/N 18549

Code 80 - Vent Cap

Code	Description	Size					
		25/50/75/100	125	130	165/200	250	300/400
73	Capacitor	--	163894 (replaces 87435 and 103181)				
74	Capacitor Boot	--	--	--	103182		
75	Pressure Switch Replacement Kit (for heaters mfgd prior to 1/94)	196653 - for sea level to 4000 ft elevation for Model FE/BE htrs mfgd prior to 1/94 (Date Code ATA)					
	Pressure Switch (for heaters mfgd beginning 1/94 (Date Code ATA))	196654 - for above 4000 ft elevation for Model FE/BE htrs mfgd prior to 1/94 (Date Code ATA)					
76	Sensing Tube Assy - heaters mfgd prior to 1/94	97210	--	97208			
	Sensing Tube Assy - heaters mfgd beginning 1/94	129859			129860		
77	Silicone Rubber Tubing - heaters mfgd prior to 1/94	(1)123571 - 9-3/4"	--	(2) 98221 - 3-1/2"		(1) 98221 - 3-1/2"	
	Silicone Rubber Tubing - heaters mfgd beginning 1/94	(1)123572 - 10-1/2"	--	(1)130389 - 3"		(1)113774 - 4"	
78	Strain Relief, Heyco #SR-5KN-5	98393					
79	RBM Relay (WR 90-370)	18549 (To replace relay P/N 98118, order Replacement Kit P/N 263527.)					
80	Vent Cap - FE and BE	111848 - 4"	111849 - 5"	111848 - 4"	111849 - 5"	111850 - 6"	
81	Flue Exhaust Tape (not illustrated)	98266, Aluminum Tape, 550°F, 1" x 10 yds (Same as Option FA1)					

Optional Power Venter for Gravity-Vent Units - Models F and B

Code	Description	Size								
		25/50	75/100	125	130	165	200	250/300	400	
90 - Power Venter Kits	115 volt Venter, Venter Adapter, & Parts Bag (Same as Option CA1 - includes two hanger bracket assemblies for converting fan units to 4-pt suspension.)	98467		136862	98468			98471		
	208 volt Venter, Venter Adapter, & Parts Bag (Same as Option CA2 - includes two hanger bracket assemblies for converting fan units to 4-pt suspension.)	--	--	135441	98469			98472		
	230 volt Venter, Venter Adapter, & Parts Bag (Same as Option CA3 - includes two hanger bracket assemblies for converting fan units to 4-pt suspension.)	--	--	135442	98470			98473		
Replacement Component Parts for Optional Power Venters										
91	Venter Assy including Blower and Motor and Wheel Assy (includes 92, 93, 94, 96,	115 volt	97976						97955	
		208 volt	--	--	97977			97956		
		230 volt	--	--	97978			97957		
92	Blower Housing Ass em by	6631						10529		
93	Venter Motor and Wheel Ass em by	115 volt	97980						97958	
		208 volt	--	--	97981			97959		
		230 volt	--	--	97982			97960		
93A	Venter Motor only	115 volt	61069, Fasco #7121-4861						87434, Fasco #7161-1775	
		208 volt	--	--	30249, Fasco #7162-0186					
		230 volt	--	--	29571, Fasco #7162-0158					
93B	Wheel, Torrington	29791, #AA-326-215-1						29792, #AA408-228-1		
93C	Fan Blade, 3", RHG-0.3125 bore	29793								
94A	Capacitor	--	--	--	--	--	--	163894 (replaces 103181)		
94B	Capacitor Boot, Sysntex #147-78	--	--	--	--	--	--	103182		
95	Time Delay Relay, P/N 259518, replacement for venter kits manufactured beginning 2/2010. For kits manufactured before 2/2010, order time delay replacement kit, P/N 259521. (Venters requiring this kit will have a TI #6000060-17 time delay relay.)									
96	Sail Switch, Cemco	97908, #JMP-154 4B-A						97907, #JMP 102-4B-C		
97	Venter Adapter Assembly	97823		146094	97824			97825		
98	Parts Bag for installing all Option CA Power Venters	97966, (See component list below.)								
98A	Flue Restrictor (not illustrated, included in Code 90)	98665 2-3/4x6	98664 2x6	97943 1x7	97944 1-1/2x7-3/4	97943 1x7	None	97944 1-1/2x 7-3/4	None	
99	Conduit Connector, Tinnerman #C54882-017	(2) 97941								
100	Flexible Conduit, 5/16" x 24"	(2) 17950								
101	Vent Cap for Model F or B with optional power vent. Vent cap is not included in Code 90 kit. (Illustration is same as Code 80, page 14.)	111848 - 4"						111850 - 6"		
102	Flue Exhaust Tape (not included in Code 90 kit)	98266, Aluminum tape 550°F, 1" x 10 yds (not illustrated)								

Code 90 - Power Venter Kit (Parts Bag Not Illustrated - See Code 98)

91 - Venter Assy

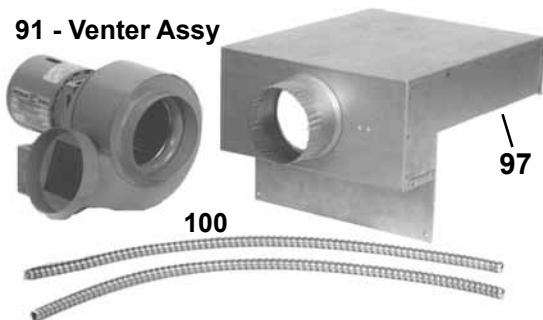

Code 93B - Venter Wheel



Code 93C - Venter Fan Blade



Code 94A - Capacitor, P/N 163894



Code 96 - Sail Switch



Code 98 Parts Bag - Parts Bag, P/N 97966, is standardized for all sizes of power venters. It contains all of the items required for any installation and may include parts that are not used. The highlighted descriptions in **bold type** should always be used. Each parts bag includes:

Qty	P/N	Description
2	96386	Hanger Assembly
1	98364	Brown Wire Assembly
2	97941	Conduit Connector, Tinnerman #C54882-017
13	16354	Twist-on Wire Connector, Ideal #3-0273
11	11813	Sheetmetal Screws, #10 x 1/2"
1	16199	Box Connector, %&B #253
1	1417	90° Box Connector
2	16358	Anti-Short Bushing (red)
1	91453	Orange Wire, 18 Gauge x 60", 105°C
1	38463	Yellow Wire, 18 Gauge x 60", 105°C
1	38464	Brown Wire, 18 Gauge x 60", 105°C
1	3841	Black Wire, 18 Gauge x 36", 105°C
1	87880	White Wire, 18 Gauge x 36", 105°C
1	38462	Blue Wire 18 Gauge x 60", 105°C
2	148086	Open/Closed Bushing, Heyco #OCB625
1	97843	Restrictor, 1" Wide
1	97944	Restrictor, 1-1/2" Wide
1	98664	Restrictor, 2" Wide
1	99665	Restrictor, 2-3/4" Wide
2	16355	Wire Nuts (used for field connection on blower models)
1	103171	Warning Label

Code 99 - Conduit Connector



Code 100 - Flexible Conduit

100

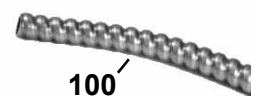

Heat Exchangers

A gasket kit is included with replacement heat exchangers for Model B and BE heaters. If a new burner rack support is required, order P/N listed. Burner rack supports manufactured prior to 8/91 (Serial No. Date Code AQH) were not indexed.

Code	Description			Size										
				25	50	75	100	125	130	165	200	250	300	400
110	Heat Exchanger Assembly	Aluminized	F/FE	102282	102283	102284	102285	132743	102286	102287	102288	102289	102290	102291
			B/BE	173823	173824	173825	173826	173827	173828	173829	173830	173831	173832	173833
	409 Stainless	F/FE	102311	102312	102313	102314	132745	102315	102316	102317	102318	102319	102320	
		B/BE	173834	173835	173836	173837	173838	173839	173840	173841	173842	173843	173844	
110A	Gasket Kit included in Replacement Heat Exchangers for blower models. Kit includes five self-adhesive gasket strips, a tube of sealant and instructions.			102280					102281					
111	Indexed Burner Rack Support			113936					113937					

Code 110 - Heat Exchanger



Code 111 - Burner Rack Supports

P/N 113937 - Burner Rack Support for Sizes 250-400

(Same as Code 52 on page 12)

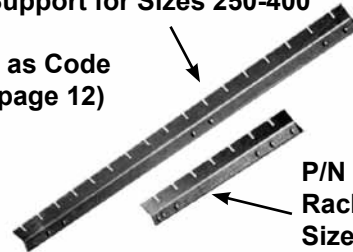

P/N 113936, Burner Rack Support for Sizes 25-200

Cabinet Parts

Code	Description		Size										
			25	50	75	100	125	130	165	200	250	300	400
120	Top Front		94661	94662	94663	94665	94663	94664	94665	94666		94667	
121	Bottom Front		94668	94669	94670	94672	94670	94671	94672	94673	94673	94674	
122	Right Side Outer Panel		104968					104970					
123	Left Side Outer Panel		104969					104971					
124	Fan/Limit Access Panel		94898										
125	Wiring Access Panel		94897										
126	Bottom Pan		94687	94688	94689	94690	131607	94691	94692	94693	94694	94695	94696
127	Right Hinge Pin Assy for Bottom Panel		96445										
	Left Hinge Pin Assy for Bottom Panel		99351										
128	Fan Back Panel - Fan Model		94675	94676	161181	161184	N/A	161182	94680	161183		94682	
129	Back Panel - Blower Model		99830	99831	99832	99835	99833	99834	99835	99836		99837	
130	Latch Fastener for Fan Back		(2) 96435 - used prior to 2/95										
131	Horizontal Louver Assembly		94851	94855	94857	131803	94859	94863	94865	94867		94869	
			(4)	(4)	(4)	(4)	(6)	(4)	(6)	(6)	(8)	(8)	(10)
132	Inner Left Side Panel		94842					94837					
133	Inner Right Side Panel (includes plate for electrical supply)		F/FE	99025					99026				
			B/BE	102346					102347				
134	Upper Stiffening Channel		B/BE 100867 (2)					100869 (2)					
135	Lower Stiffening Channel		B/BE 100868 (2)					100870 (2)					
136	Air Deflectors (not illustrated)												
	Horizontal - Right Side		F/FE	--	--	--	--	--	96141			94899	
	Vertical - Right Side		All	96714	--	--	--	--	--	--	--	--	--
	Horizontal - Left Side		F/FE	--	96140	--	--	--	96140	96141			94900
137A	Vertical Barrier		94749					94750					
			94751										
138A (See NOTE Below)	Draffhood for Gravity Vent Sizes 25-200		102449	102450	102451	131608	102838	102839	102840	--	--	--	
	Draffhood Assy for F/B Sizes 250-400		--	--	--	--	--	--	--	101909		101910	
	Components: Draffhood Front		--	--	--	--	--	--	--	105310		105311	
	Draffhood Right Rear		--	--	--	--	--	--	--	101903		101904	
	Draffhood Left Rear		--	--	--	--	--	--	--	101906		101907	
Screws, #10x1/2"		--	--	--	--	--	--	--	51489 (6)				
138B	Flue Collar Assy - Models F & B		102363	102364	102365	132765	102844	102845		102846	102847		
138C	Flue Collar Support - Models F & B		--	--	--	--	131992	--	--	--	102857		
138D	Cover for Horizontal/Vertical Vent Outlet		--	--	--	--	132764	--	--	--	102855		

NOTE: Effective 4/1/91, all gravity-vent Model F and B heaters include a blocked vent system requiring holes in the draffhood. When replacing a draffhood on a heater without a blocked vent switch, these holes will not affect heater operation.

Code	Description	25	50	75	100	125	130	165	200	250	300	400
(On sizes 25-100 and 130-200, the cover and flue collar assembly are one piece)												
139	Flue Baffle Assy - Models F & B	100859	100886	100887	100860	131811	100861	100862	100863	100864	100865	100866
140	Flue Collection Box Assy - FE & BE	97744		97746	97747	131804	97748	97749	97750	97751	97752	97753
141A	Flue Baffle - Models FE & BE	--	--	97783	97784	134766	97785	97786	97787	101008	101009	101010
141B	Flue Baffle Clamp - Models FE & BE	--	--	98196								
142	Adapter Back including Baffles - B/BE	100871		100872	100873	131975	100874	100875	100876	100877		100878

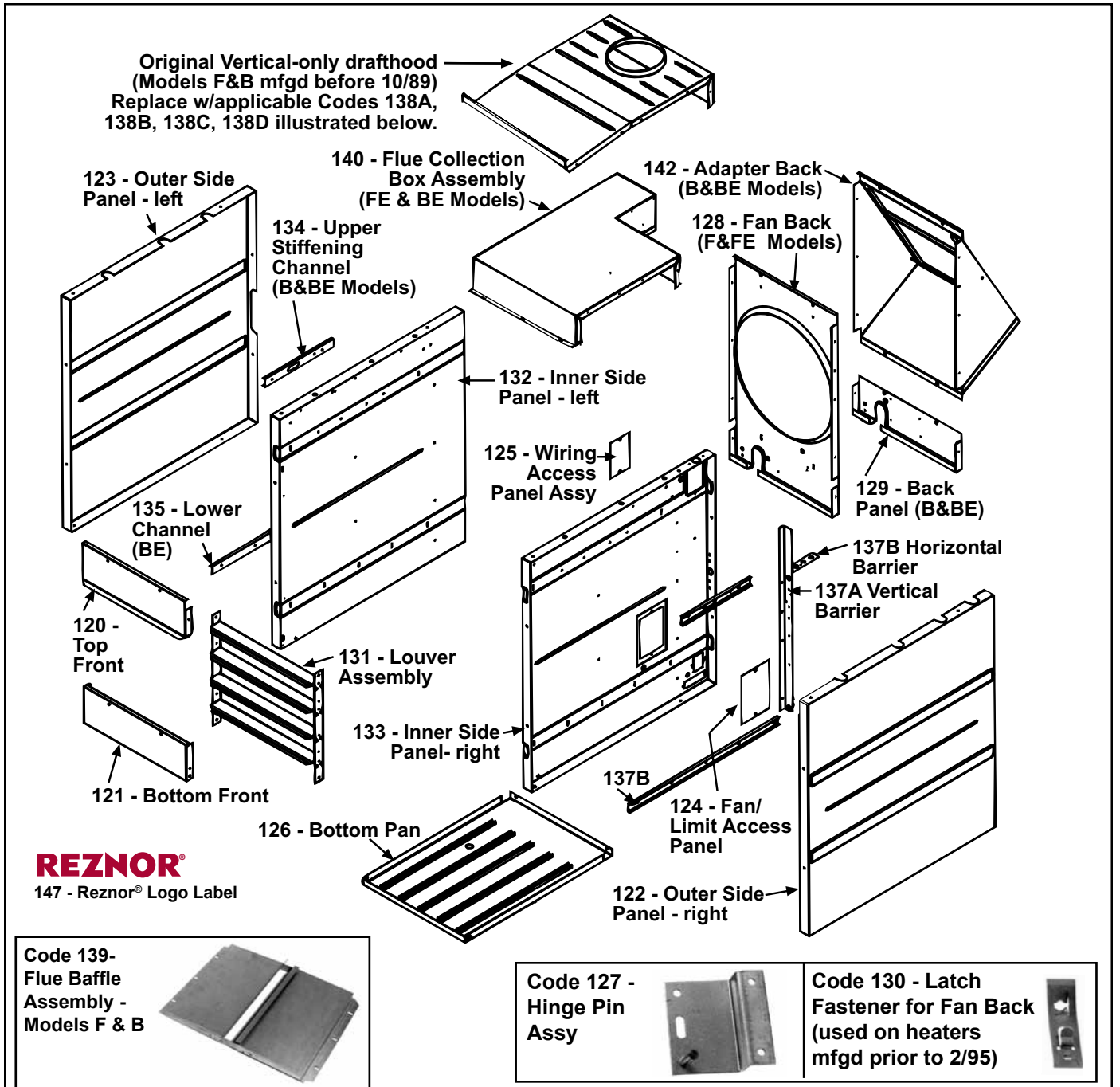

Model F/B Drafthoods (heaters manufactured beginning 10/89)

Sizes 25-100, 130-200

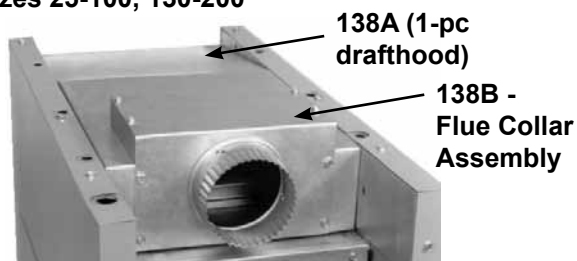

Sizes 125, 250-400

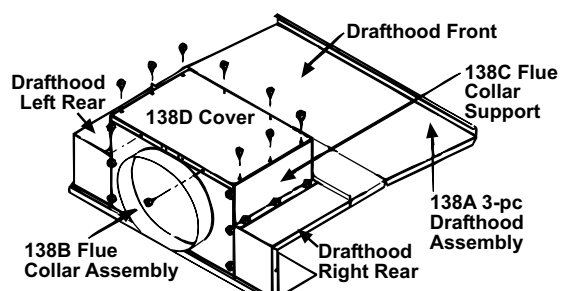

Cabinet Parts and Options (cont'd)

Code	Description	Size										
		25	50	75	100	125	130	165	200	250	300	400
145	Vertical Louver Assy (Same as CD1)	98500	98501	98502	136863	98503	98504	98505	98506	98507		
145A	Vertical Louver Top/Btm Member only	97852	97853	97854	97856	97854	97855	97856	97857	97858		
145B	Vertical Louver only		95937					95938				
146	Duct Flange Kit (Same as CD9) - B/BE	101194	101194	101195	101501	135591	101196	101197	101198	101199	101199	101200
146A	Duct Flange Top & Btm - in CD9 & AX4	101155	101155	101156	101157	101159	101157	101158	101159	101160	101160	101161
146B	Duct Flange Sides - in CD9 & AX4	101163	101163	101163	101163	101163	101164	101164	101164	101164	101164	101164
147	Reznor® Logo Label							196690				
148	Tawny Beige Touch-up Paint, 10oz spray							37919				
149	Maroon Touch-up Paint, 12oz spray can							207432 (louver color)				

Code 145 - Vertical Louver Assembly (Same as Option CD1)

On fan models, do not use vertical louvers with optional discharge nozzles.

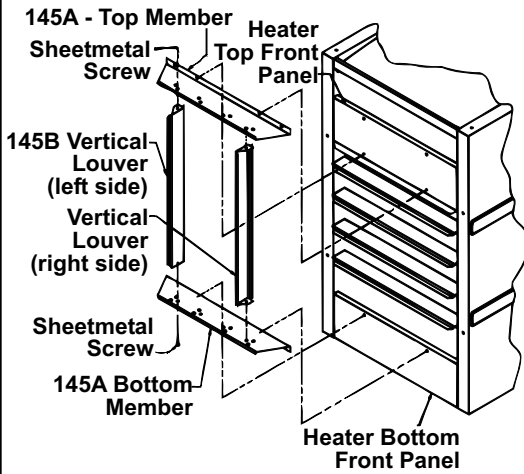

Code 146 - Duct Flange Parts

(Same as Option CD9; components used in Option AX4)



Code 149 - Vent Cap - Model F/B with Gravity Vent

NOTE: Same type of vent cap applies to a gravity or power vent installation. The required size of vent cap varies; for power vent sizes, see Code 80, page 14, for FE and BE or Code 101, page 15, for F and B with power vent option.



Applies to Model F&B Size with a gravity vent	Vent Cap Diameter	P/N
25-50	4"	111848
75	5"	111849
100	6"	111850
125, 130	* 8"	61857
165, 200	8"	61857
250, 300	10"	61866
400	12"	61875

* Run 7" vent pipe and use a field-supplied increaser with an 8" vent cap.

Hangers and Optional Hanger Kits

Code	Description	Models	P/N
150	Hanger Bracket Assy (2 standard on each fan unit, 4 standard on each blower unit)	F/FE25-400 & B/BE25-400	96386
151	Four-Point Suspension Kit (Same as Option CK7)	F/FE25-400	98508
152	Swivel Connection Kit for Two-Point Suspension (Same as Option CK8)	F/FE25-400	98509
153	Four-Point Suspension with Swivel Connections Kit (Same as Option CK9)	F/FE25-400	98510
154	Swivel Connection Kit for Four-Point Suspension (Same as Option CK10)	F/FE25-400 & B/BE25-400	98511
Components in Swivel Connection Hanger Kits CK8, CK9, and CK10 listed above:			
	Swivel Connection only (to adapt for hanging from 1" threaded pipe)	All	17627
	Lock Washers for installing Swivel Connections	All	5197
155	Pressure Switch Bracket only (required when installing Code 151 or 153 on Model FE Sizes 25-100 manufactured prior to 8/92 - Date Code ARI)	FE 25-100 mfgd prior to 8/92 - order separately;	98448
156	8-32 Nut for installation of Pressure Switch Bracket (Code 155)	not included in option kits	31522
157	Four-Point Suspension Kit designed to carry a nearly equal load at each suspension point (Same as Option CK19)	B/BE165-400	165742
Components in Hanger Kit Option CK19:			
157A	Right Side Hanger Bar	B/BE165-400	162829
157B	Left Side Hanger Bar	B/BE165-400	162830
157C	HHD Tap Bolts 3/8-16NCX 11-1/2 #5	B/BE165-400	(4)114350
157D	3/8" Lockwasher	B/BE165-400	(8)5197

Code 150 - Hanger Bracket



Code 151 - Kit to Convert Fan Model to 4-Pt Suspension (Same as Opt CK7)



Code 152 - Swivel Connection Kit for 2-Pt Suspension



(Same as Opt CK8)

Code 153 - Kit to Convert to 4-Pt Suspension with Swivel Connections (Same as Option CK9)





Code 154 - Swivel Connection Kit for 4-Pt Suspension (Same as Option CK10)



Code 157 - 4-Pt Suspension for Models B/BE - designed to equalize the load (Same as Option CK19)



Optional Belt and Blower Guards - Blower Models B and BE

 	Code	Description	Size				
			25	50/75/100	125	130/165	200/250/300/400
	160	Guard Package (Same as Option CD10) for Sizes 50-400 w/Belt Drive Motor	--	101539	101540	101541	
	161	Guard Package (Same as Option CD12) for Sizes 25-100 w/Direct Drive Motor	114548	--	--	--	
Components:							
162	Belt Guard only - in Option CD10 & AZ6	--	193796	193797	193795		
163	Contacting Mounting Bracket (not illustrated) - in Option CD10	--	101405	--	--		
164	Blower Inlet Guard only - in Options CD10, CD12, AZ6, & AZ7		102474	102475			

Optional Blower/Filter Cabinet - Blower Models B and BE

Code	Description	Size								
		25/50	75	100	125	130	165	200	250/300	400
165	Blower/Filter Cabinet Pkg for Field Assy, Adaptable for 1" or 2" filters (Same as Option CW1)	101543	101544	101545	140836	101546	101547	101548	101549	101550
166	Blower/Filter Cabinet Package for Field Assy, includes 1" Filters (Same as Option CW2)	101628	101629	101630	140884	101631	101632	101633	101634	101635
167	Blower/Filter Cabinet Package for Field Assy, includes 2" Filters (Same as Option CW3)	101636	101637	101638	140885	101639	101640	101641	101642	101643
Components:										
168	Top and Bottom Panel	99707			140841		100642		--	--
169	Top Right and Bottom Left	--	--	--	--	--	--	--	101582	101584
170	Top Left and Bottom Right	--	--	--	--	--	--	--	101583	101585
171	Stiffening Channel for Top/Btm	--	--	--	--	--	--	--	101551	
172	Stiffening Angle for Top/Btm	--	--	--	--	--	--	--	101601	101602
173	Right Side Hanger		101578				101580			
174	Left Side Hanger		101579			101581				
175	Front Leg	99761	99762	99763	137404	100634	100635	100636	100637	100638
176	Top Filler Panel Assembly	101562	101563	101564	140838	101565	101566	101567	101568	101569
177	Bottom Filler Panel Assembly	101570	101571	101572	140840	101573	101574	101575	101576	101577
178	Rear Leg		99708			100639			100640	100641
179	Door		99712			100646				
180	Plastic Plug for Door Holes		82177							
181	Door Stop		99711			100645				
182	Center Filter Bracket Assembly	--	--	--	--	101624			101625	101626
183	Filter Angle		99710			101591			101592	101593
184	Filter Member		99709			101595			101596	101597
185	Permanent Aluminum Filters									
	16" x 20" x 1"	--	--	--	--	--	--	--	(2)101607	--
	20" x 20" x 1"	101608							(2)101608	--
	16" x 25" x 1"	--	--	--		101609			--	(2)101609
	20" x 25" x 1"	--	--	--		101610			--	(2)101610
	16" x 20" x 2"	--	--	--	--	--	--	--	(2)101620	--
	20" x 20" x 2"	101621			--	--	--	--	(2)101621	--
	16" x 25" x 2"	--	--	--	101622				--	(2)101622
20" x 25" x 2"	--	--	--	101623				--	(2)101623	

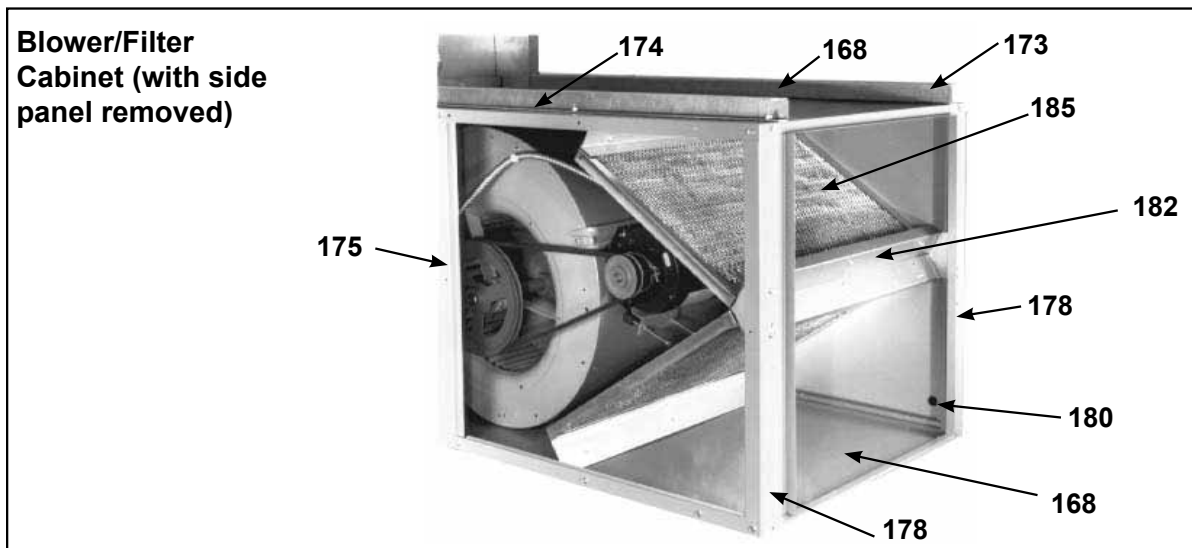

Optional Downturn Air Outlet Nozzles - All Models (See NOTE in the illustration.)

Code	Description	Size								
		25/50	75	100	125	130	165	200	250/300	400
195	Downturn Nozzle Kit, 25-65° Variable Air Deflection Range, including hanger brackets to convert fan units to 4-point suspension (Same as Option CD2)	98525	98526	98527	135512	98528	98529	98530	98531	98532
196	Downturn Nozzle Kit, 50-90° Variable Air Deflection Range, including hanger brackets to convert fan units to 4-point suspension (Same as Option CD3)	98533	98534	98535	135513	98536	98537	98538	98539	98540
197	Downturn Nozzle Kit, 25-65° Variable Air Deflection Range w/ Vertical Louvers, including hanger brackets to convert fan units to 4-pt suspension (Same as Option CD4)	98541	98542	98543	135510	98544	98545	98546	98547	98548
198	Downturn Nozzle Kit, 50-90° Variable Air Deflection Range with Vertical Louvers (Same as Option CD5) - B&BE ONLY	124918	124919	124920	137302	124921	124922	124923	124924	124926
Downturn Nozzle Parts in CD2, CD3, CD4 and CD5 (for vertical louver components, see page 18)										
199	Downturn Nozzle Side Panel only	97874				97875				
200	Downturn Nozzle Top Panel only	97876	97877	97878	135509	97879	97880	97881	97882	97904

Outlet Nozzle Options CD2 & CD4

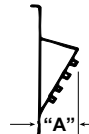

Sizes	"A"	Range of Air Deflection
25-125	9" (229mm)	25°-65°
130-400	13" (330mm)	25°-65°

NOTE: On fan models, DO NOT use vertical louvers in combination with Code 196 (Option CD3). DO NOT install Code 198 (Option CD5) on fan models.

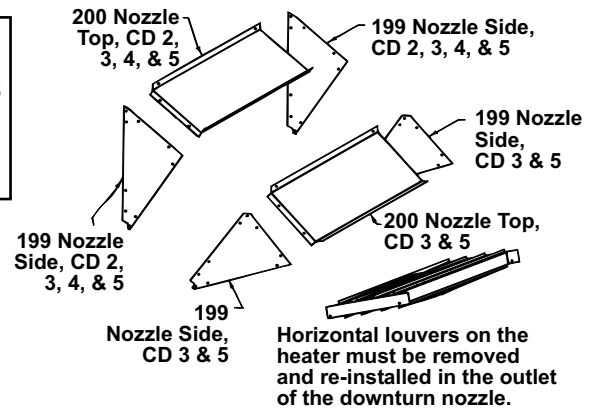

Outlet Nozzle Options CD3 & CD5



Sizes	"A"	Range of Air Deflection
25-125	16-1/2" (419mm)	50°-90°
130-400	23-1/2" (597mm)	50°-90°

Optional Polytube Adapters - Blower Models B and BE Sizes 75-400

Code	Description	Size							
		75	100	125	130	165	200	250/300	400
210	Polytube Adapter for Suspended Units w/Polytube Discharge Above or Below Heater Discharge (Same as Opt CD6)	101243	101244	137299	122086	101245	101246	101247	101248
	Polytube Adapter for Suspended Units w/Polytube Discharge directly in line with Heater Discharge (Same as Opt CD11)	104227	104228	137301	122087	104229	104230	104231	104232
211	Polytube Adapter for Floor-Mounted Units (Same as Option CD8) - Requires the addition of guards, Code 50.	101680	101681	137300	122160	101682	101683	101684	101685

Size	75	100	125	130	165	200	250/300	400
Components Common to Suspended and Floor-Mounted Polytube Adapters:								
212	Discharge Panel Assy, CD6,8,11		101249			101250		
213	Discharge Collar Clamp - CD6,8,11		101499			146463		
214	Adapter Left Side, CD6,8	101253	132066	101254	101255	101254		
215	Adapter Right Side, CD6,8	101259	132066	101260	101255	101260		
214/215	Adapter Side, CD11 (2 required)	104233	132195	104234	104235	104234		
216	Adapter Top, CD6,8	101266	101267	132062	121548	101268	101269	101270
	Adapter Top, CD11	104236	104237	132063	121546	104238	104239	104240
217	Adapter Btm, CD6,8	101272	101273	132062	121547	101274	101275	101276
	Adapter Btm, CD11	104242	104243	132064	121545	104244	104245	104246
218	Polytube Holes Location Label	101263 - CD6, 8, 11 (not illustrated)						
Components for Floor-Mounted Adapter only:								
219	Blower Support Assembly	101686						
220	Blower Legs	101689						
221	Support Angles	101691						
222	Cross Brace	101690						
223	Adapter Legs	101692						

Code 211 - Polytube Adapter with Floor Mounts

